



# FRÍO INDUSTRIAL / INDUSTRIAL COLD ABATIDORES DE TEMPERATURA / BLAST CHILLERS

G11 PAG.06/11



G11 PAG.12/15

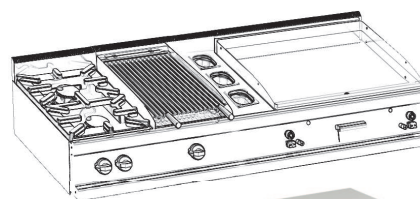

G11 PAG.18/23



G11 PAG.26/29



G11 PAG.32/37



G11 PAG.40/49



G11 PAG.52/55



G11 PAG.58/61



ACCESORIOS/ACCESSORIES

G11 PAG.62/64

FROID INDUSTRIEL / INDUSTRIELLE KÄLTE  
CELLULES DE REFRROIDISSEMENT RAPIDE / SCHNELLKÜHLER

## CONSTRUCCIÓN

- Exterior e interior de acero inoxidable 18/18 AISI-304. El trasero es de acero galvanizado.
- Encimeras con canto frontal redondeado. Murales, con peto posterior de 100 mm. **1**
- Cuba interna con cantos redondeados para facilitar la limpieza. **2** Y desagüe en la base.
- Aislamiento de poliuretano inyectado ecológico (libre de CFC) con una densidad de 40 Kgs/m<sup>3</sup>, de 60 mm. de espesor.
- Con patas regulables de acero inoxidable.
- Bisagras de torsión, en las puertas. Con posición de mantenimiento abierta, cuando supera los 95°.
- Puertas con tirador incorporado, con cierre magnético, mediante burletes dotados de cámara de aire, para asegurar la estanqueidad. Fácilmente sustituibles. **3**
- Grupos frigoríficos sobre-dimensionados, con desescarche automático. Dichos grupos permiten su extracción para facilitar el servicio de mantenimiento y limpieza del condensador.
- Frío ventilado para conseguir la temperatura homogénea en el interior de la cámara.
- Gas refrigerante hidrocarburo R290. De máximo rendimiento para obtener la calificación energética mas ecológica, y para reducir la emisiones de CO<sub>2</sub>.
- Temperatura de trabajo 0 +4° C, en conservación y -18° -22° C en congelación, con una temperatura ambiente de +36° C.
- Con termómetro-termostato electrónico digital. Dicho programador permite ajustar las temperaturas, máxima y mínima, así como los desescarches automáticamente, con el fin de optimizar al máximo, el rendimiento del frigorífico.
- Con interruptor luminoso de marcha-paro.
- Se suministran en dotación, con una rejilla por puerta.

## MESAS FRÍAS DE CONSERVACIÓN CON PUERTAS CIEGAS

- Se fabrican en dos profundidades. La de 600 mm. y la GN 1/1 de 700 mm.

## MESAS FRÍAS CENTRALES DE CONSERVACIÓN

- Para su ubicación central. Sin peto.
- Se fabrican en dos profundidades. La de 600 mm. y la GN 1/1 de 700 mm.
- Opcionalmente, se pueden pedir con el trasero de acero inox. **4** Ver ACCESORIOS.

## MESAS FRÍAS DE CONGELACIÓN

- Diseñadas para el mantenimiento de congelados, pudiendo colocarlas en la cocina, para tener los alimentos, cerca de la zona de cocción y así evitar desplazamientos a la cámara de congelación. Pero el producto debe estar previamente congelado.
- Se fabrican en dos profundidades. La de 600 mm. y la GN 1/1, de 700 mm.

## MESAS FRÍAS DE CONSERVACIÓN CON FREGADERO

- Con escurridor y seno de 340x370x150 mm. A la derecha de la encimera. **5**
- Opcionalmente, se puede suministrar con grifo monomando, o para usar como lavamanos, con caño y pedal, para agua fría-caliente. **6** Ver ACCESORIOS.
- Se fabrican en dos profundidades. De de 600 mm. y la GN 1/1, de 700 mm.

## MESAS FRÍAS DE CONSERVACIÓN CON PUERTAS DE CRISTAL

- Con las puertas dotadas de cristal doble, con cámara de aire. Con cerradura **7**
- Se fabrican en dos profundidades. La de 600 mm. y la GN 1/1, de 700 mm.

## MESAS FRÍAS PARA MOTOR A DISTANCIA

- Ocupan menos longitud, al no llevar grupo frigorífico incorporado, con lo que se evita el ruido del mismo, y las averías por la absorción de grasas y suciedad, cuando se limpian los suelos.
- Disponen de un frontal de mandos, donde está el termómetro-termostato, y el interruptor de marcha-paro.
- Equipan una válvula de expansión, para su conexión a la tubería del gas refrigerante, que viene del compresor.
- El grupo frigorífico, es aconsejable colocarlo en el exterior, lo cual hace que rindan mas. Dicho montaje debe efectuarlo un instalador frigorista.
- Se fabrican en dos profundidades. La de 600 mm. y la GN 1/1, de 700 mm.

## MESAS FRÍAS DE CONSERVACIÓN CON CAJONES Y PUERTAS

- Cajones perforados para facilitar la ventilación. Dotados de guías correderas telescópicas, de acero inoxidable, que permiten la apertura al 100%. **8**
- Con cierre magnético, mediante burletes con cámara de aire, al igual que las puertas, fácilmente sustituibles.
- Se fabrican en dos profundidades. La de 600 mm. y la GN 1/1, de 700 mm.

## RESERVAS FRÍAS DE CONSERVACIÓN CON CAJONES

- De altura 600 mm. Diseñadas para colocar en su encimera, aparatos de cocción de 600/Snack ó 700 ó 900 de fondo. Son muy prácticas para el cocinero, ya que le permite tener el género, perfectamente clasificado, debajo del frytop, barbacoa o cocina. Aparte de aprovechar al máximo el espacio, en cocinas pequeñas.
- Se fabrican GN 1/1 de 700 mm. de profundidad.
- Existen con dos tamaños de cajones. El grande, con una altura interna de 300 mm. Y los pequeños, que van uno encima del otro, de 100 mm. de altura útil.
- Dichos cajones son perforados para facilitar la ventilación. Dotados de guías telescópicas, de acero inoxidable, que permiten la apertura al 100% **8**
- Con cierre magnético, mediante burletes con cámara de aire, para asegurar la estanqueidad. Fácilmente sustituibles.

## VER PÁGINAS DE ACCESORIOS

- A destacar, que se puede suministrar cualquier modelo de mesa fría, OPCIONALMENTE, con el grupo frigorífico, a la izquierda, pues de serie van a la derecha.
- También, la posibilidad de colocar un KIT LAVAMANOS, con pedal para agua fría-caliente, encima del grupo frigorífico. **9**
- Así mismo encontrarán, rejillas, soportes, recipientes GN etc.

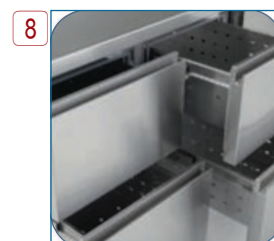
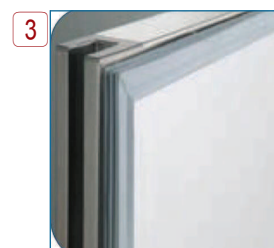

## E

## MAKING

- Exterior and interior in 18/18 AISI-304 stainless steel. The rear is galvanized steel.
- Worktops with rounded front edge. Murals, with 100 mm rear bib. <sup>[1]</sup>
- Internal tank with rounded edges to facilitate cleaning. <sup>[2]</sup> And drain at the base.
- Ecological injected polyurethane insulation (CFC-free) with a density of 40 Kgs / m<sup>3</sup>, 60 mm. of thickness.
- With adjustable stainless steel legs.
- Torsion hinges on the doors. With open maintenance position, when it exceeds 95°.
- Doors with built-in handle, with magnetic closure, by means of weatherstripping with an air chamber, to ensure watertightness. Easily replaceable. <sup>[3]</sup>
- Oversized refrigeration units, with automatic defrost. These groups allow its extraction to facilitate the service of maintenance and cleaning of the condenser.
- Cool ventilated to achieve a homogeneous temperature inside the chamber.
- R290 hydrocarbon refrigerant gas. Maximum performance to obtain the most ecological energy rating, and to reduce CO<sub>2</sub> emissions.
- Working temperature 0 + 4° C, in conservation and -18° -22° C in freezing, with an ambient temperature of + 36° C.
- With digital electronic thermometer-thermostat. This programmer allows to adjust the temperatures, maximum and minimum, as well as the defrosts automatically, in order to optimize to the maximum, the performance of the refrigerator.
- With light start-stop switch.
- They are supplied with one grid per door.

## COLD CONSERVATION TABLES WITH BLIND DOORS

- They are manufactured in two depths. The 600 mm. and the GN 1/1 of 700 mm.

## COLD CENTRAL CONSERVATION TABLES

- For its central location. No bib.
- They are manufactured in two depths. The 600 mm. and the GN 1/1 of 700 mm.
- Optionally, they can be ordered with a stainless steel rear. <sup>[4]</sup> See ACCESSORIES.

## COLD FREEZING TABLES

- Designed for the maintenance of frozen, being able to place them in the kitchen, to have food, near the cooking area and thus avoid movements to the freezing chamber. But the product must be previously frozen.
- They are manufactured in two depths. The 600 mm. and the GN 1/1, 700 mm.

## COLD STORAGE TABLES WITH SINK

- With drainer and 340x370x150 mm bowl. To the right of the counter. <sup>[5]</sup>
- Optionally, it can be supplied with a single-lever tap, or to use as a sink, with spout and pedal, for cold-hot water. <sup>[6]</sup> See ACCESSORIES.
- They are manufactured in two depths. 600 mm. and the GN 1/1, 700 mm.

## COLD CONSERVATION TABLES WITH GLASS DOORS

- With double glass doors, with an air chamber. With lock <sup>[7]</sup>
- They are manufactured in two depths. The 600 mm. and the GN 1/1, 700 mm.

## COLD TABLES FOR REMOTE ENGINE

- They take less length, since they do not have a built-in refrigerator group, which prevents noise from it, and breakdowns due to the absorption of grease and dirt, when floors are cleaned.
- They have a front of controls, where is the thermometer-thermostat, and the start-stop switch.
- They are equipped with an expansion valve, for its connection to the refrigerant gas line, which comes from the compressor.
- The refrigerator group, it is advisable to place it outside, which makes them perform more. Said assembly must be carried out by a refrigeration installer.
- They are manufactured in two depths. The 600 mm. and the GN 1/1, 700 mm.

## COLD CONSERVATION TABLES WITH DRAWERS AND DOORS

- Perforated drawers for easy ventilation. Equipped with telescopic sliding guides, in stainless steel, that allow 100% opening. <sup>[8]</sup>
- With magnetic closure, by means of weatherstripping with an air chamber, like the doors, easily replaceable.
- They are manufactured in two depths. The 600 mm. and the GN 1/1, 700 mm.

## COLD STORAGE CONSERVATION WITH DRAWERS

- Height 600 mm. Designed to place 600 / Snack or 700 or 900 bottom cooking appliances on your counter. They are very practical for the cook, since it allows him to have the gender, perfectly classified, under the frytop, barbecue or kitchen. In addition to making the most of space, in small kitchens.
- 700 mm GN 1/1 are manufactured. deep.
- They exist with two sizes of drawers. The big one, with an internal height of 300 mm. And the small ones, which go one on top of the other, of 100 mm. of useful height.
- Said drawers are perforated to facilitate ventilation. Equipped with telescopic guides, in stainless steel, that allow 100% opening <sup>[8]</sup>
- With magnetic closure, by means of weatherstripping with an air chamber, to ensure tightness. Easily replaceable.

## SEE ACCESSORY PAGES

- Remarkably, any cold table model can be supplied, OPTIONALLY, with the refrigeration unit on the left, as standard they go on the right.
- Also, the possibility of placing a KIT SINK, with pedal for cold-hot water, on top of the refrigerator group. <sup>[9]</sup>
- You will also find grids, supports, GN containers, etc.

## F

## CONSTRUCTION

- Extérieur et intérieur en acier inoxydable 18/18 AISI-304. L'arrière est en acier galvanisé.
- Plans de travail avec bord avant arrondi. Peintures murales, avec bavette arrière de 100 mm. <sup>[1]</sup>
- Réservoir interne aux bords arrondis pour faciliter le nettoyage. <sup>[2]</sup> Et égouttez à la base.
- Isolation écologique en polyuréthane injecté (sans CFC) avec une densité de 40 Kgs / m<sup>3</sup>, 60 mm. épais.
- Avec pieds réglables en acier inoxydable.
- La torsion s'articule sur les portes. Avec position de maintenance ouverte, lorsqu'elle dépasse 95°.
- Portes avec poignée intégrée, à fermeture magnétique, au moyen de coupe-bise avec chambre à air, pour assurer l'étanchéité. Facilement remplaçable. <sup>[3]</sup>
- Unités de réfrigération surdimensionnées, avec dégivrage automatique. Ces groupes permettent son extraction pour faciliter le service d'entretien et de nettoyage du condenseur.
- Ventilé frais pour atteindre une température homogène à l'intérieur de la chambre.
- Gaz réfrigérant hydrocarboné R290. Des performances maximales pour obtenir la cote énergétique la plus écologique et réduire les émissions de CO<sub>2</sub>.
- Température de travail 0 + 4° C, en conservation et -18° -22° C en congélation, avec une température ambiante de + 36° C.
- Avec thermomètre-thermostat électronique numérique. Ce programmeur permet d'ajuster automatiquement les températures, maximum et minimum, ainsi que les dégivrages, afin d'optimiser au maximum les performances du réfrigérateur.
- Avec interrupteur marche / arrêt léger.
- Ils sont fournis avec une grille par porte.

## TOURS RÉFRIGÉRÉES AVEC PORTES AVEUGLES

- Ils sont fabriqués en deux profondeurs. Le 600 mm. et le GN 1/1 de 700 mm.

## TOURS RÉFRIGÉRÉES CENTRALES

- Pour son emplacement central. Pas de dossard.
- Ils sont fabriqués en deux profondeurs. Le 600 mm. et le GN 1/1 de 700 mm.
- En option, ils peuvent être commandés avec un arrière en acier inoxydable. <sup>[4]</sup> Voir ACCESSOIRES.

## TOURS RÉFRIGÉRÉES DE CONGÉLATION

- Conçu pour l'entretien des surgelés, pouvoir les placer dans la cuisine, pour avoir des aliments, près de la zone de cuisson et ainsi éviter les mouvements vers la chambre de congélation. Mais le produit doit être préalablement congelé.
- Ils sont fabriqués en deux profondeurs. Le 600 mm. et le GN 1/1, 700 mm.

## TOURS RÉFRIGÉRÉES AVEC ÉVIER

- Avec égouttoir et cube 340x370x150 mm. À droite du comptoir. <sup>[5]</sup>
- En option, il peut être fourni avec un robinet à levier unique, ou pour être utilisé comme un évier, avec bec et pédale, pour l'eau froide-chaude. <sup>[6]</sup> Voir ACCESSOIRES.
- Ils sont fabriqués en deux profondeurs. 600 mm. et le GN 1/1, 700 mm.

## TOURS RÉFRIGÉRÉES AVEC PORTES EN VERRE

- Avec double portes vitrées, avec chambre à air. Avec serrure <sup>[7]</sup>
- Ils sont fabriqués en deux profondeurs. Le 600 mm. et le GN 1/1, 700 mm.

## TOURS RÉFRIGÉRÉES POUR MOTEUR À DISTANCE

- Ils prennent moins de longueur, car ils n'ont pas de groupe de réfrigérateurs intégrés, ce qui évite le bruit et les pannes dues à l'absorption de graisse et de saleté lors du nettoyage des sols.
- Ils ont une façade de commandes, où se trouve le thermomètre-thermostat et l'interrupteur marche / arrêt.
- Ils sont équipés d'un détendeur, pour son raccordement à la conduite de gaz réfrigérant, qui provient du compresseur.
- Le groupe réfrigérateur, il est conseillé de le placer à l'extérieur, ce qui les rend plus performants. Cet assemblage doit être effectué par un installateur en réfrigération.
- Ils sont fabriqués en deux profondeurs. Le 600 mm. et le GN 1/1, 700 mm.

## TOURS RÉFRIGÉRÉES AVEC TIROIRS ET PORTES

- Tiroirs perforés pour une ventilation facile. Equipé de guides coulissants télescopiques, en acier inoxydable, qui permettent une ouverture à 100%. <sup>[8]</sup>
- Avec fermeture magnétique, au moyen de coupe-froid avec une chambre à air, comme les portes, facilement remplaçable.
- Ils sont fabriqués en deux profondeurs. Le 600 mm. et le GN 1/1, 700 mm.

## TOURS RÉFRIGÉRÉES BASSES AVEC DES TIROIRS

- Hauteur 600 mm. Conçu pour placer des appareils de cuisson 600 / Snack ou 700 ou 900 à fond sur votre comptoir. Ils sont très pratiques pour le cuisinier, car cela lui permet d'avoir le genre, parfaitement classé, sous le frytop, le barbecue ou la cuisine. En plus de profiter au maximum de l'espace, dans les petites cuisines.
- 700 mm GN 1/1 sont fabriqués. profond.
- Ils existent avec deux tailles de tiroirs. Le grand, avec une hauteur intérieure de 300 mm. Et les petits, qui vont l'un sur l'autre, de 100 mm. de hauteur utile.
- Ces tiroirs sont perforés pour faciliter la ventilation. Equipé de guides télescopiques, en acier inoxydable, qui permettent une ouverture à 100% <sup>[8]</sup>
- Avec fermeture magnétique, au moyen de coupe-bise avec une chambre à air, pour assurer l'étanchéité. Facilement remplaçable.

## VOIR LES PAGES ACCESSOIRES

- Remarquablement, n'importe quel modèle de table froide peut être fourni, EN OPTION, avec l'unité de réfrigération à gauche, en standard, ils vont à droite.
- Aussi, la possibilité de placer un KIT SINK, avec pédale pour eau froide-chaude, au-dessus du groupe réfrigérateur. <sup>[9]</sup>
- Vous trouverez également des grilles, des supports, des conteneurs GN, etc.



# MESAS FRÍAS CON PUERTAS CIEGAS

E COLD TABLES WITH BLIND DOORS  
A TOURS RÉFRIGÉRÉES À PORTES INOX

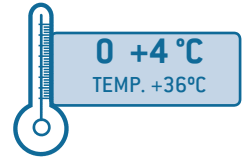

↗ 600 71979509    ↗ 700 75789509

↗ 600 72579509    ↗ 700 72589509



↗ 600 70289509    ↗ 700 79099509

ACCESORIOS  
E ACCESSORIES  
F ACCESSOIRES



↗ 63390000

OPTIONAL



MOD. / COD.							€
72579509	98	1500x600x850	2	2 - 460x405	250	400W - 230/1V	1.810
71979509	116	2020x600x850	3	3 - 460x405	390	400W - 230/1V	2.150
70289509	143	2545x600x850	4	4 - 460x405	530	400W - 230/1V	2.550
72589509	102	1345x700x850	2	2 - GN 1/1	290	400W - 230/1V	2.040
75789509	126	1800x700x850	3	3 - GN 1/1	455	400W - 230/1V	2.420
79099509	153	2245x700x850	4	4 - GN 1/1	615	400W - 230/1V	2.860

# MESAS FRÍAS CENTRALES CON PUERTAS CIEGAS



E CENTRAL COLD TABLES WITH BLIND DOORS  
F TOURS RÉFRIGÉRÉES CENTRALES À PORTES INOX

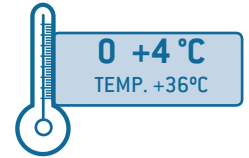

↗ 600 7C257950 | ↗ 700 7C258950



↗ 600 7C197950 | ↗ 700 7C578950



↗ 600 7C028950 | ↗ 700 7C909950

ACCESORIOS  
E ACCESSORIES  
F ACCESSOIRES

↗ INOX TOTAL

↗ 63390000

OPTIONAL

GAS  
R290



MOD. / COD.							€
7C257950	98	1500x600x850	2	2 - 460x405	250	400W - 230/1V	1.810
7C197950	116	2020x600x850	3	3 - 460x405	390	400W - 230/1V	2.150
7C028950	143	2545x600x850	4	4 - 460x405	530	400W - 230/1V	2.550
7C258950	102	1345x700x850	2	2 - GN 1/1	290	400W - 230/1V	2.040
7C578950	126	1800x700x850	3	3 - GN 1/1	455	400W - 230/1V	2.420
7C909950	153	2245x700x850	4	4 - GN 1/1	615	400W - 230/1V	2.860





# MESAS DE CONGELACIÓN CON PUERTAS CIEGAS

- E FREEZING TABLES WITH BLIND DOORS
- F TABLES DE CONGELATION À PORTES

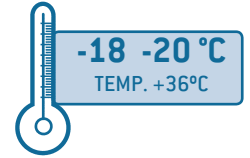

↗ 600 **79389509** | ↗ 700 **75299509**



↗ 600 **70489509** | ↗ 700 **71399509**



**SON PARA MANTENIMIENTO DE CONGELADOS.  
EL PRODUCTO DEBE ESTAR PREVIAMENTE CONGELADO.**

- E THEY ARE FOR FROZEN MAINTENANCE.  
THE PRODUCT MUST BE PREVIOUSLY FROZEN.
- F ILS SONT POUR L'ENTRETIEN SURGELÉ.  
LE PRODUIT DOIT ÊTRE PRÉCÉDEMMENT CONGELÉ.

**GAS**  
**R290**



MOD. / COD.							
<b>79389509</b>	113	1500x600x850	2	2 - 460x405	250	600 W - 230/1V	<b>2.370</b>
<b>70489509</b>	139	2020x600x850	3	3 - 460x405	390	700 W - 230/1V	<b>2.730</b>
<b>75299509</b>	125	1345x700x850	2	2 - GN 1/1	290	600 W - 230/1V	<b>2.730</b>
<b>71399509</b>	152	1800x700x850	3	3 - GN 1/1	455	700 W - 230/1V	<b>3.210</b>





# MESAS FRÍAS CON PUERTAS CIEGAS Y FREGADERO



E COLD TABLES WITH BLIND DOORS AND SINK

F TOUR RÉFRIGÉRÉE AVEC DES PORTES PLEINES ET ÉVIER

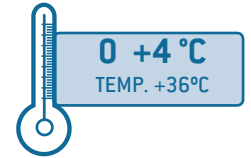

↗ 600 74579509 | ↗ 700 79589509



↗ 600 73089509 | ↗ 700 72989509



↗ 600 70389509 | ↗ 700 70199509

ACCESORIOS  
E ACCESSORIES  
F ACCESSOIRES

↗ 2222299

↗ 2222236

OPTIONAL



MOD. / COD.							€
74579509	98	1500x600x800	2	2 - 460x405	250	400W - 230/1V	2.310
73089509	116	2020x600x850	3	3 - 460x405	390	400W - 230/1V	2.650
70389509	143	2545x600x850	4	4 - 460x405	530	400W - 230/1V	3.060
79589509	102	1345x700x850	2	2 - GN1/1	290	400W - 230/1V	2.550
72989509	126	1800x700x850	3	3 - GN1/1	455	400W - 230/1V	2.910
70199509	153	2245x700x850	4	4 - GN1/1	615	400W - 230/1V	3.245



# MESAS FRÍAS CON PUERTAS DE CRISTAL

- E COLD TABLES WITH GLASS DOORS
- F TOURS RÉFRIGÉRÉES À PORTES VITRÉES

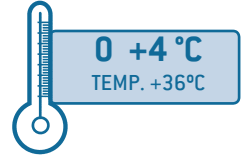

↗ 600 77089509    ↗ 700 73548609



↗ 600 75579509    ↗ 700 78589509



↗ 600 73289509    ↗ 700 76199509



ACCESORIOS  
E ACCESSORIES  
F ACCESSOIRES



↗ 63390000

OPTIONAL

- GAS  
R290
- 
- 
- 
- 

MOD. / COD.							€
75579509	101	1500x600x850	2	2 - 460x405	250	400W - 230/1V	2.105
77089509	118	2020x600x850	3	3 - 460x405	390	400W - 230/1V	2.590
73289509	146	2545x600x850	4	4 - 460x405	530	400W - 230/1V	3.135
78589509	103	1345x700x850	2	2 - GN 1/1	290	400W - 230/1V	2.340
73548609	128	1800x700x850	3	3 - GN 1/1	455	400W - 230/1V	2.790
76199509	155	2245x700x850	4	4 - GN 1/1	615	400W - 230/1V	3.445

# MESAS FRÍAS PARA MOTOR A DISTANCIA

E REMOTE MOTOR COLD FURNITURE  
F TOURS RÉFRIGÉRÉES POUR MOTEUR À DISTANCE



↗ 600 7D257950 | ↗ 700 7D258950



↗ 600 7D197950 | ↗ 700 7D578950



↗ 600 7D028950 | ↗ 700 7D909950



\* Grupo recomendado  
E Recommended group  
F Groupe recommandé

MOD. / COD.						UC *	€
7D257950	55	1195x600x850	2	2 - 460x405	250	1/4 HP	1.520
7D197950	84	1720x600x850	3	3 - 460x405	390	1/3 HP	1.870
7D028950	114	2245x600x850	4	4 - 460x405	530	3/8 HP	2.270
7D258950	63	1045x700x850	2	2 - GN 1/1	290	1/4 HP	1.615
7D578950	92	1500x700x850	3	3 - GN 1/1	455	1/3 HP	1.980
7D909950	122	1945x700x850	4	4 - GN 1/1	615	3/8 HP	2.345



# MESAS FRÍAS CON CAJONES Y PUERTAS

E COLD TABLES WITH DRAWNS AND DOORS  
F TOURS RÉFRIGÉRÉES À TIROIRS ET PORTES

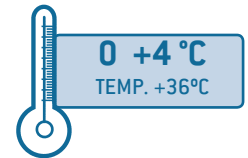

↗ 600 71679509 | ↗ 700 75689509



↗ 600 70679509 | ↗ 700 74689509



↗ 600 72189509 | ↗ 700 77099509



↗ 600 71189509 | ↗ 700 76099509



↗ 600 70189509 | ↗ 700 78099509







GAS  
R290



ACCESORIOS  
E ACCESSORIES  
F ACCESSOIRES





↗ 63390000  
OPTIONAL

MOD. / COD.								€
71679509	108	1500x600x850	1	1 - 460x405	2	250	400 W - 230/1V	2.195
70679509	118	1500x600x850	-	-	4	250	400 W - 230/1V	2.590
72189509	126	2020x600x850	2	2 - 460x405	2	390	400 W - 230/1V	2.550
71189509	136	2020x600x850	1	1 - 460x405	4	390	400 W - 230/1V	2.930
70189509	146	2020x600x850	-	-	6	390	400 W - 230/1V	3.310
75689509	112	1345x700x850	1	1 - GN 1/1	2	290	400 W - 230/1V	2.505
74689509	122	1345x700x850	-	-	4	290	400 W - 230/1V	2.980
77099509	136	1800x700x850	2	2 - GN 1/1	2	455	400 W - 230/1V	2.880
76099509	146	1800x700x850	1	1 - GN 1/1	4	455	400 W - 230/1V	3.355
78099509	156	1800x700x850	-	-	6	455	400 W - 230/1V	3.830

# MESAS FRÍAS CON CAJONES Y PUERTAS

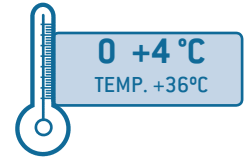
E COLD TABLES WITH DRAWERS AND DOORS  
F TOURS RÉFRIGÉRÉES À TIROIRS ET PORTES



600 73770609 | 700 71299509



600 78289509 | 700 74299509



600 77289509 | 700 72299509



600 79289509 | 700 73299509

ACCESORIOS  
E ACCESSORIES  
F ACCESSOIRES

63390000  
OPTIONAL



MOD. / COD.								€
73770609	153	2545x600x850	3	3 - 460x405	2	530	400 W - 230/1V	2.930
78289509	163	2545x600x850	2	2 - 460x405	4	530	400 W - 230/1V	3.315
77289509	173	2545x600x850	1	1 - 460x405	6	530	400 W - 230/1V	3.700
79289509	183	2545x600x850	-	-	8	530	400 W - 230/1V	4.075
71299509	163	2245x700x850	3	3 - GN 1/1	2	615	400 W - 230/1V	3.320
74299509	173	2245x700x850	2	2 - GN 1/1	4	615	400 W - 230/1V	3.795
72299509	183	2245x700x850	1	1 - GN 1/1	6	615	400 W - 230/1V	4.270
73299509	193	2245x700x850	-	-	8	615	400 W - 230/1V	4.745





# RESERVAS FRÍAS CON CAJONES

E COLD RESERVES WITH DRAWERS  
F RESERVES FROIDES AVEC TIROIRS

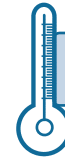

0 +4 °C  
TEMP. +36°C



700 74489509



700 75489509



700 76489509

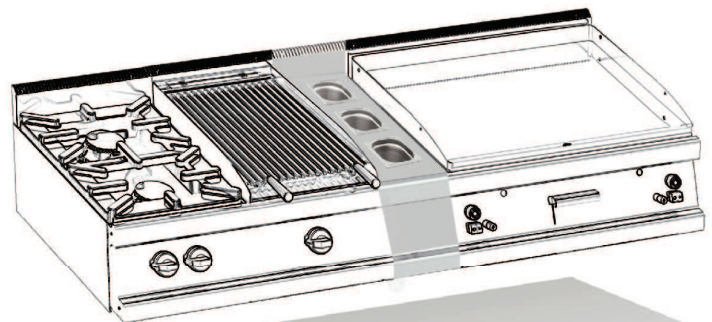

700 74770609



GAS  
R290



MOD. / COD.							€
74489509	97	1345x700x600	2	-	105	400W - 230/1V	2.195
75489509	102	1345x700x600	1	1	105	400W - 230/1V	2.550
76489509	116	1800x700x600	3	-	170	400W - 230/1V	2.640
74770609	126	1800x700x600	1	2	170	400W - 230/1V	3.225



# RESERVAS FRÍAS CON CAJONES

E COLD RESERVES WITH DRAWERS  
F RESERVES FROIDES AVEC TIROIRS

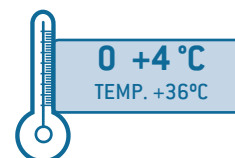

700 77489509



700 78489509

GAS  
R290



MOD. / COD.							€
77489509	138	2245x700x600	4	-	230	400W - 230/1V	3.270
78489509	153	2245x700x600	1	3	230	400W - 230/1V	3.850



## CONSTRUCCIÓN

- Exterior e interior de acero inoxidable 18/18 AISI-304. El trasero es de acero galvanizado.
- Encimeras con canto frontal redondeado. Murales, con peto posterior de 100 mm. **1**
- Cuba interna con cantos redondeados para facilitar la limpieza. **2** Y desagüe en la base.
- Aislamiento de poliuretano inyectado ecológico (libre de CFC) con una densidad de 40 Kgs/m<sup>3</sup>, de 60 mm. de espesor.
- Con patas regulables de acero inoxidable.
- Bisagras de torsión, en las puertas. Con posición de mantenimiento abierta, cuando supera los 95°.
- Puertas con tirador incorporado, con cierre magnético, mediante burletes dotados de cámara de aire, para asegurar la estanqueidad. Fácilmente sustituibles. **3**
- Con cajón neutro, ubicado encima del compresor. OPCIONALMENTE, dicho cajón, puede ser pica-marro. **4** Ver ACCESORIOS., ya que si lo desean, pueden colocar la máquina del café encima del mueble.
- Grupos frigoríficos sobre-dimensionados, con desescarche automático. Dichos grupos permiten su extracción para facilitar el servicio de mantenimiento y limpieza del condensador.
- Frío ventilado para conseguir la temperatura homogénea en el interior de la cámara.
- Gas refrigerante hidrocarburo R290. De máximo rendimiento para obtener la calificación energética mas ecológica, y para reducir la emisiones de CO<sub>2</sub>.
- Temperatura de trabajo 0 +4° C, con una temperatura ambiente de +36° C.
- Con termómetro-termostato electrónico digital. Dicho programador permite ajustar las temperaturas, máxima y mínima, así como los desescarches automáticamente, con el fin de optimizar al máximo, el rendimiento del frigorífico.
- Con interruptor luminoso de marcha-paro.
- Se suministran en dotación, con dos rejillas por puerta.
- Se fabrican con una profundidad de 600 mm.
- Estan concebidos para su colocación en la pared de la zona del bar, por ello tienen una altura de 1.050 mm. y hacen conjunto con los muebles cafeteros y vajilleros de tras-barra, de la misma altura. (Ver GRUPO 14-ELEMENTOS NEUTROS).

## CONTRAMOSTRADORES CON PUERTAS DE CRISTAL

- Con las puertas dotadas de cristal doble, con cámara de aire.
- Con cerradura en cada puerta. **5**
- Con luz led.

## BOTELLEROS

- Exterior e interior de acero inoxidable. Traseros de acero galvanizado.
- Cuba interna con los cantos redondeados para facilitar la limpieza y desagüe en el interior de la cámara. **2**
- Aislamiento de poliuretano inyectado ecológico (libre de CFC) con una densidad de 40 Kgs./m<sup>3</sup>.
- Con patas regulables, excepto modelos Serie 2.
- Con puertas correderas en la encimera. **6**
- Con rejillas separadoras, verticalmente.
- Grupos frigoríficos sobre-dimensionados. Desescarche manual. Dichos grupos permiten su extracción para faciitar el servicio de mantenimiento y limpieza del condensador con la máxima comodidad.
- Frío estático.
- Gas refrigerante hidrocarburo R600a. De máximo rendimiento para obtener la calificación energética mas ecológica, y para reducir las emisiones de CO<sub>2</sub>.
- Temperatura de trabajo +1 +8° C, con una temperatura ambiente de +36° C.
- Con termostato analógico.
- Con interruptor luminoso de marcha-paro.

## FABRICADORES DE CUBITOS

- Exterior en acero inoxidable. Interior en ABS. Traseros en acero galvanizado.
- Fabrican los cubitos de hielo macizo de 40 gramos. **7**
- Se fabrican 5 modelos, cuya producción hora y capacidad almacenada, viene especificada en cada uno de ellos. **8**
- Aislamiento de poliuretano inyectado ecológico (libre de CFC) con una densidad de 40 Kgs./m<sup>3</sup>.
- Equipo frigorífico tropicalizado, pudiendo trabajar con una temperatura ambiente de 43°C, y con el agua a 35°C.
- Gas refrigerante R404a
- Refrigeración del condensador por aire.
- Con patas regulables.

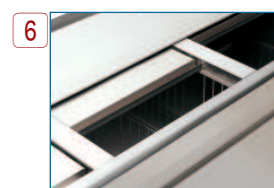



E

**MAKING**

- Outside and inside in 18/18 AISI-304 stainless steel. The rear is galvanized steel.
- Worktops with rounded front edge. Murals, with 100 mm rear bib. **1**
- Internal tank with rounded edges to facilitate cleaning. **2** And drain at the base.
- Ecological injected polyurethane insulation (CFC-free) with a density of 40 Kgs / m<sup>3</sup>, 60 mm. of thickness.
- With adjustable stainless steel legs.
- Torsion hinges on the doors. With open maintenance position, when it exceeds 95°.
- Doors with built-in handle, with magnetic closure, by means of weatherstripping provided with an air chamber, to ensure sealing. Easily replaceable. **3**
- With neutral drawer, located on top of the compressor. OPTIONALLY, said drawer can be pica-marro. **4** See ACCESSORIES., Since if you wish, you can place the coffee machine on top of the cabinet.
- Oversized refrigeration units, with automatic defrost. These groups allow its extraction to facilitate the service of maintenance and cleaning of the condenser.
- Cool ventilated to achieve a homogeneous temperature inside the chamber.
- R290 hydrocarbon refrigerant gas. Maximum performance to obtain the most ecological energy rating, and to reduce CO<sub>2</sub> emissions.
- Working temperature 0 + 4° C, with an ambient temperature of + 36° C.
- With digital electronic thermometer-thermostat. This programmer allows to adjust the temperatures, maximum and minimum, as well as the defrosts automatically, in order to optimize to the maximum, the performance of the refrigerator.
- With light start-stop switch.
- They are supplied with two screens per door.
- They are manufactured with a depth of 600 mm.
- They are designed to be placed on the wall of the bar area, therefore they have a height of 1,050 mm. and they are combined with the coffee furniture and behind-the-counter crockery, of the same height. [See GROUP 14-NEUTRAL ELEMENTS].

**COUNTER COUNTERS WITH GLASS DOORS**

- With double glass doors, with an air chamber.
- With lock on each door. **5**
- With led light.

**BOOTEL COOLERS**

- Outside and inside in stainless steel. Galvanized steel rear.
- Internal tank with rounded edges to facilitate cleaning and drainage inside the chamber.
- Ecological injected polyurethane insulation (CFC-free) with a density of 40 Kgs./m<sup>3</sup>.
- With adjustable feet, except Series 2 models.
- With sliding doors on the counter. **6**
- With separating grids, vertically.
- Oversized refrigerator groups. Manual defrost. These groups allow their extraction to facilitate the service of maintenance and cleaning of the condenser with the maximum comfort.
- Static cold.
- Hydrocarbon refrigerant gas R600a. Maximum performance to obtain the most ecological energy rating, and to reduce CO<sub>2</sub> emissions.
- Working temperature +1 + 8° C, with an ambient temperature of + 36° C.
- With analog thermostat.
- With light start-stop switch.

**ICE CUBE MAKERS**

- Stainless steel outside. Inside in ABS. Rear in galvanized steel.
- They make the 40-gram solid ice cubes. **7**
- 5 models are manufactured, whose hourly production and stored capacity is specified in each of them. **8**
- Ecological injected polyurethane insulation (CFC-free) with a density of 40 Kgs./m<sup>3</sup>.
- Tropicalized refrigerator equipment, being able to work with an ambient temperature of 43°C, and with water at 35°C.
- Refrigerant gas R404a
- Air condenser cooling.
- With adjustable legs.

F

**CONSTRUCTION**

- Extérieur et intérieur en acier inoxydable 18/18 AISI-304. L'arrière est en acier galvanisé.
- Plans de travail avec bord avant arrondi. Murales, avec dossard de 100 mm. **1**
- Réservoir interne aux bords arrondis pour faciliter le nettoyage. **2** Et égouttez à la base.
- Isolation écologique en polyuréthane injecté (sans CFC) avec une densité de 40 Kgs / m<sup>3</sup>, 60 mm. épais.
- Avec pieds réglables en acier inoxydable.
- La torsion s'articule sur les portes. Avec position de maintenance ouverte, lorsqu'elle dépasse 95°.
- Portes avec poignée intégrée, à fermeture magnétique, au moyen de coupe-bise munis d'une chambre à air, pour assurer l'étanchéité. Facilement remplaçable. **3**
- Avec tiroir neutre, situé sur le dessus du compresseur. FACULTATIVEMENT, ledit tiroir peut être pica-marro. **4** Voir ACCESSOIRES., Puisque si vous le souhaitez, vous pouvez placer la machine à café sur le dessus du meuble.
- Unités de réfrigération surdimensionnées, avec dégivrage automatique. Ces groupes permettent son extraction pour faciliter le service d'entretien et de nettoyage du condenseur.
- Ventilé frais pour atteindre une température homogène à l'intérieur de la chambre.
- Gaz réfrigérant hydrocarboné R290. Des performances maximales pour obtenir la cote énergétique la plus écologique et réduire les émissions de CO<sub>2</sub>.
- Température de travail 0 + 4° C, avec une température ambiante de + 36° C.
- Avec thermomètre-thermostat électronique numérique. Ce programmeur permet d'ajuster automatiquement les températures, maximum et minimum, ainsi que les dégivrages, afin d'optimiser au maximum les performances du réfrigérateur.
- Avec interrupteur marche / arrêt léger.
- Ils sont fournis avec deux grille par porte.
- Ils sont fabriqués avec une profondeur de 600 mm.
- Ils sont conçus pour être placés sur le mur de la zone du bar, ils ont donc une hauteur de 1050 mm. et ils sont combinés avec les meubles de café et la vaisselle derrière le comptoir, de la même hauteur. [Voir GROUPE 14-ÉLÉMENTS NEUTRES].

**TOURS RÉFRIGÉRÉS HAUTES AVEC PORTES EN VERRE**

- Avec double portes vitrées, avec chambre à air.
- Avec serrure sur chaque porte. **5**
- Avec lumière led.

**REFROIDISSEUR DE BOUTEILLES**

- Extérieur et intérieur en acier inoxydable. Arrière en acier galvanisé.
- Réservoir interne avec bords arrondis pour faciliter le nettoyage et le drainage à l'intérieur de la chambre.
- Isolation écologique en polyuréthane injecté (sans CFC) avec une densité de 40 Kgs./m<sup>3</sup>.
- Avec pieds réglables, sauf modèles de la série 2.
- Avec portes coulissantes sur le comptoir. **6**
- Avec des grilles de séparation, verticalement.
- Groupes réfrigérants surdimensionnés. Dégivrage manuel. Ces groupes permettent leur extraction pour faciliter le service d'entretien et de nettoyage du condenseur avec le maximum de confort.
- Froid statique.
- Gaz réfrigérant hydrocarbure R600a. Des performances maximales pour obtenir la cote énergétique la plus écologique et réduire les émissions de CO<sub>2</sub>.
- Température de travail +1 + 8° C, avec une température ambiante de + 36° C.
- Avec thermostat analogique.
- Avec interrupteur marche / arrêt léger.

**MACHINE À GLAÇONS SOLIDES**

- Extérieur en acier inoxydable. Intérieur en ABS. Arrière en acier galvanisé.
- Ils font les glaçons solides de 40 grammes. **7**
- 5 modèles sont fabriqués, dont la production horaire et la capacité de stockage sont spécifiées dans chacun d'eux. **8**
- Isolation écologique en polyuréthane injecté (sans CFC) avec une densité de 40 Kgs./m<sup>3</sup>.
- Équipement frigorifique tropicalisé, pouvant fonctionner avec une température ambiante de 43°C, et avec de l'eau à 35°C.
- Gaz réfrigérant R404a
- Refroidissement du condenseur à air.
- Avec pieds réglables.



# CONTRA MOSTRADORES CON PUERTAS CIEGAS

- E REFRIGERATED COUNTER WITH DOORS
- F TOUR RÉFRIGÉRÉES HAUTE AVEC PORTES

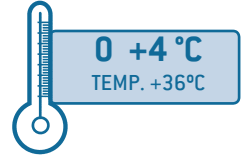

600 71579509



600 76979509



600 73189509







**ACCESORIOS**  
E ACCESSORIES  
F ACCESSOIRES

**OPTIONAL**

 **71400M70**

KIT CAJÓN PICAMARROS  
E SHIM FOR DRAWER  
F KIT TIROIR À MARCS



MOD. / COD.								€
71579509	116	1500x600x1050	2	4 - 460x405	1	335	400W - 230/1V	2.035
76979509	134	2020x600x1050	3	6 - 460x405	1	520	400W - 230/1V	2.455
73189509	161	2545x600x1050	4	8 - 460x405	1	700	400W - 230/1V	2.860

# CONTRA MOSTRADORES CON PUERTAS DE CRISTAL



E REFRIGERATED COUNTER WITH GLASS DOORS  
F TOUR RÉFRIGÉRÉES HAUTE AVEC PORTES VITRÉES

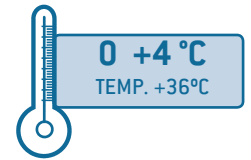

600 76969509



600 70879509



600 75189509

**ACCESORIOS**  
E ACCESSORIES  
F ACCESSOIRES

**OPTIONAL**

71400M70

KIT CAJÓN PICAMARROS  
E SHIM FOR DRAWER  
F KIT TIROIR À MARCS

GAS R290

MOD. / COD.								€
76969509	120	1500x600x1050	2	4 - 460x405	1	335	400W - 230/1V	2.350
70879509	140	2020x600x1050	3	6 - 460x405	1	520	400W - 230/1V	2.845
75189509	169	2545x600x1050	4	8 - 460x405	1	700	400W - 230/1V	3.440



# BOTELLEROS

**E** BOTTLE COOLERS  
**F** RAFRAÎCHISSEUR DE BOISSONS

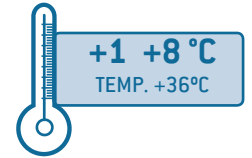

550 72712509



550 74712509



550 75712509

**GAS**  
**R600a**



**INTERIOR Y EXTERIOR DE ACERO INOX.**  
**E** INSIDE AND OUTSIDE IN STAINLESS STEEL.  
**F** ACIER INOXYDABLE POUR INTÉRIEUR ET EXTÉRIEUR.

MOD. / COD.						€
72712509	72	1500x550x850	3	420	400 W - 230/1V	1.180
74712509	87	2000x550x850	4	580	400 W - 230/1V	1.380
75712509	103	2500x550x850	5	720	600 W - 230/1V	1.725

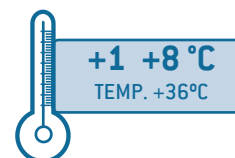

550 74699209



550 75699209



550 76699209



INTERIOR Y EXTERIOR DE ACERO INOX.  
 E INSIDE AND OUTSIDE IN STAINLESS STEEL.  
 F ACIER INOXYDABLE POUR INTÉRIEUR ET EXTÉRIEUR.

MOD. / COD.						€
74699209	55	1020x550x850	2	200	300 W - 230/1V	750
75699209	67	1525x550x850	3	365	300 W - 230/1V	1.045
76699209	81	2030x550x850	4	550	400 W - 230/1V	1.250

# FABRICADORES DE CUBITOS MACIZOS

- E SOLID ICE-CUBE MAKER
- F MACHINE À GLAÇONS SOLIDE

TEMP. +43°C  
TEMP. H2O +35°C



**78100G08**



**78200G08**

**GAS**  
**R404a**

STOCK

MOD. / COD.					Kg			€
78100G08	39	365x495x600	25 Kg/24h	625	6	150	500W - 230/1V	1.395
78200G08	48	500x585x685	37 Kg/24h	925	15	375	700W - 230/1V	1.695

# FABRICADORES DE CUBITOS MACIZOS

E SOLID ICE-CUBE MAKER  
F MACHINE À GLAÇONS SOLIDE

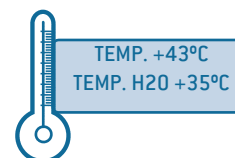

▲ 78300G08



▲ 78500G13 / 78600G13

GAS  
R404a

MOD. / COD.					STOCK			€
					Kg			
78300G08	52	500x585x795	50 Kg/24h	1250	25	625	800W - 230/1V	1.875
78500G13	67	740x605x1015	80 Kg/24h	2000	40	1000	1.050W - 230/1V	2.785
78600G13	74	740x605x1015	100 Kg/24h	2500	60	1500	1.200W - 230/1V	3.005

## CONSTRUCCIÓN

- Exterior e interior en acero inoxidable AISI-304. 18/10. El trasero es de acero galvanizado.
- Cuba interna con los cantos redondados para facilitar la limpieza y desagüe en el interior de la cámara. **1**
- Aislamiento de poliuretano inyectado ecológico (libre de CFC) con una densidad de 40 Kgs./m<sup>3</sup>, de 60 mm de espesor.
- Con patas regulables.
- Bisagras de torsión, en todas las puertas. Con posición de mantenimiento abierta, cuando supera los 95 grados.
- Puertas con cierre magnético, mediante burletes dotados de cámara de aire, para asegurar la estanqueidad. Fácilmente sustituibles.
- Grupos frigoríficos sobre-dimensionados, con desescarche automático. Dichos grupos permiten su extracción para facilitar el servicio de mantenimiento y limpieza del condensador con la máxima comodidad.
- Frio ventilado para conseguir la temperatura homogénea en el interior de la cámara.
- Gas refrigerante hidrocarburo R290. De máximo rendimiento para obtener la calificación energética más ecológica y para reducir las emisiones de CO<sub>2</sub>.
- Temperatura de trabajo 0 +4° C, con una temperatura ambiente de +36° C.
- Con termómetro-termostato electrónico digital. Dicho programador permite ajustar las temperaturas, máxima y mínima, así como los desescarches automáticamente, con el fin de optimizar al máximo el rendimiento del frigorífico.
- Con interruptor luminoso de marcha-paro.

## MUEBLES DE PREPARACIÓN DE PIZZAS

- Son para rejillas o latas EURONORM, de 400X600 mm.
- En dotación 1 rejilla EN, por cada puerta.
- La profundidad son 800 mm.
- Existen dos modelos que combinan la parte inferior, con un mueble neutro, con 5 cajones para la fermentación de las bolas de la masa de las pizzas. **2**
- Todos los modelos con la encimera de granito, incluidos los laterales y el trasero, para soportar el refrigerador de ingredientes independiente. **3**
- El mueble neutro con 5 cajones para las bolas de pizza, también se puede suministrar independientemente.

## REFRIGERADORES DE INGREDIENTES

- Exterior e interior de acero inoxidable 18/10 AISI-304
- Aislamiento de poliuretano inyectado ecológico (libre de CFC) con una densidad de 40 Kgs./m<sup>3</sup> y de 40 mm. de espesor.
- El frío es estático, mediante serpentín de cobre, adosado a la pared interna, de la cuba, en el espacio del aislamiento, lo cual facilita la limpieza de la misma.
- Gas refrigerante hidrocarburo R600a, de máximo rendimiento para obtener la calificación energética más ecológica y para reducir las emisiones de CO<sub>2</sub>.
- Temperatura de trabajo +4° +8°C, con una temperatura ambiente de 36°C.
- Con termómetro-termostato electrónico digital, con el cual se puede ajustar las temperaturas máxima y mínima.
- Con interruptor luminoso de marcha-paro.
- Se pueden usar para ingredientes de pizza, o de bocadillos o de ensaladas.
- Llevan 4 patas regulables, de 20 mm., pero opcionalmente, se pueden suministrar con un kit de patas de 100/120 mm., para poder colocarlas en cualquier mesa de trabajo. **4**. Ver ACCESORIOS.
- Así mismo, según la utilidad, que deseen, se fabrican con vitrina de cristal, **5** para usar como estante, a la vez de hacer la función de protector higiénico, o con una tapa abatible de acero inoxidable. **6**

## MESAS FRÍAS PASTELERÍA

- Son para ubicar rejillas o latas EURONORM, de 400 x 600 mm.
- En dotación 1 rejilla EN por cada puerta.
- La profundidad son 800 mm.
- Hay modelos con encimera de acero inoxidable **7** y con encimera de granito **8**





E

**MAKING**

- Outside and inside in 18/18 AISI-304 stainless steel. The rear is galvanized steel.
- Internal tank with rounded edges to facilitate cleaning and drainage inside the chamber. **1**
- Ecological injected polyurethane insulation (CFC-free) with a density of 40 Kgs./m<sup>3</sup>, 60 mm thick.
- With adjustable legs.
- Torsion hinges on all doors. With open maintenance position, when it exceeds 95 degrees.
- Doors with magnetic closure, by means of weatherstripping with an air chamber, to ensure watertightness. Easily replaceable.
- Oversized refrigerator groups, with automatic defrost. These groups allow their extraction to facilitate the service of maintenance and cleaning of the condenser with the maximum comfort.
- Cold ventilated to achieve a homogeneous temperature inside the chamber.
- R290 hydrocarbon refrigerant gas. Maximum performance to obtain the most ecological energy rating and to reduce CO<sub>2</sub> emissions.
- Working temperature 0 + 4° C, with an ambient temperature of + 36° C.
- With digital electronic thermometer-thermostat. This programmer allows adjusting the temperatures, maximum and minimum, as well as the defrosts automatically, in order to optimize the performance of the refrigerator as much as possible.
- With light start-stop switch.

**PIZZA PREPARATION FURNITURE**

- They are for EURONORM racks or cans, 400X600 mm.
- Supplied with 1 EN grid for each door.
- The depth is 800 mm.
- There are two models that combine the lower part, with a neutral cabinet, with 5 drawers for the fermentation of the balls of the pizza dough. **2**
- All models with granite countertop including sides and rear to support separate ingredient cooler. **3**
- The neutral cabinet with 5 drawers for the pizza balls can also be supplied independently.

**INGREDIENT REFRIGERATORS**

- Exterior and interior in 18/10 stainless steel AISI-304
- Ecological injected polyurethane insulation (CFC-free) with a density of 40 Kgs./m<sup>3</sup> and 40 mm. of thickness.
- The cold is static, by means of a copper coil, attached to the internal wall of the tank, in the insulation space, which facilitates cleaning it.
- R600a hydrocarbon refrigerant gas, maximum performance to obtain the most ecological energy rating and to reduce CO<sub>2</sub> emissions.
- Working temperature + 4° + 8°C, with an ambient temperature of 36°C.
- With digital electronic thermometer-thermostat, with which you can adjust the maximum and minimum temperatures.
- With light start-stop switch.
- They can be used for pizza ingredients, or for sandwiches or salads.
- They have 4 adjustable legs, 20 mm., But optionally, they can be supplied with a kit of 100/120 mm. Legs, to be able to place them on any work table. **4**. See ACCESSORIES.
- Likewise, according to the utility, they wish, they are made with a glass showcase, **5** to be used as a shelf, at the same time as acting as a hygienic protector, or with a stainless steel hinged lid. **6**

**COLD PASTRY TABLES**

- They are for placing EURONORM racks or cans, 400 x 600 mm.
- Supplied with 1 EN grid for each door.
- The depth is 800 mm.
- There are models with **7** stainless steel worktop and **8** granite worktop

F

**CONSTRUCTION**

- Extérieur et intérieur en acier inoxydable AISI-304. 10/18. L'arrière est en acier galvanisé.
- Réservoir interne avec bords arrondis pour faciliter le nettoyage et le drainage à l'intérieur de la chambre. **1**
- Isolation écologique en polyuréthane injecté (sans CFC) d'une densité de 40 Kgs./m<sup>3</sup>, 60 mm d'épaisseur.
- Avec pieds réglables.
- La torsion s'articule sur toutes les portes. Avec position de maintenance ouverte, lorsqu'elle dépasse 95 degrés.
- Portes à fermeture magnétique, au moyen de coupe-bise avec chambre à air, pour assurer l'étanchéité. Facilement remplaçable.
- Groupes réfrigérants surdimensionnés, avec dégivrage automatique. Ces groupes permettent leur extraction pour faciliter le service d'entretien et de nettoyage du condenseur avec le maximum de confort.
- Ventilé à froid pour atteindre une température homogène à l'intérieur de la chambre.
- Gaz réfrigérant hydrocarboné R290. Des performances maximales pour obtenir la cote énergétique la plus écologique et réduire les émissions de CO<sub>2</sub>.
- Température de travail 0 + 4° C, avec une température ambiante de + 36° C.
- Avec thermomètre-thermostat électronique numérique. Ce programmeur permet d'ajuster automatiquement les températures, maximum et minimum, ainsi que les dégivrages, afin d'optimiser au maximum les performances du réfrigérateur.
- Avec interrupteur marche / arrêt léger.

**MEUBLES DE PRÉPARATION DE PIZZA**

- Ils sont destinés aux grilles ou canettes EURONORM, 400X600 mm.
- Fourni avec 1 grille EN pour chaque porte.
- La profondeur est de 800 mm.
- Il existe deux modèles qui combinent la partie inférieure, avec une armoire neutre, avec 5 tiroirs pour la fermentation des boules de la pâte à pizza. **2**
- Tous les modèles avec comptoir en granit, y compris les côtés et l'arrière pour supporter un refroidisseur d'ingrédients séparé. **3**
- L'armoire neutre à 5 tiroirs pour boules à pizza peut également être fournie indépendamment.

**RÉFRIGÉRATEURS INGRÉDIENTS**

- Extérieur et intérieur en acier inoxydable 18/10 AISI-304
- Isolation écologique en polyuréthane injecté (sans CFC) avec une densité de 40 Kgs./m<sup>3</sup> et 40 mm. épais.
- Le froid est statique, au moyen d'un serpent en cuivre, fixé à la paroi interne du réservoir, dans l'espace de l'isolation, ce qui facilite son nettoyage.
- Gaz réfrigérant hydrocarboné R600a, performance maximale pour obtenir la cote énergétique la plus écologique et réduire les émissions de CO<sub>2</sub>.
- Température de travail + 4° + 8°C, avec une température ambiante de 36°C.
- Avec thermomètre-thermostat électronique numérique, avec lequel vous pouvez régler les températures maximale et minimale.
- Avec interrupteur marche / arrêt léger.
- Ils peuvent être utilisés pour les pizzas, les sandwiches ou les salades.
- Ils ont 4 pieds réglables, 20 mm., Mais en option, ils peuvent être fournis avec un kit de 100/120 mm. Pieds, pour pouvoir les placer sur n'importe quelle table de travail. **4**. Voir ACCESSOIRES.
- De même, selon l'utilité, ils souhaitent, ils sont réalisés avec une vitrine en verre, **5** à utiliser comme étagère, en même temps qu'ils agissent comme une protection hygiénique, ou avec un couvercle à charnière en acier inoxydable. **6**.

**TOURS RÉFRIGÉRÉES POUR PÂTISSERIE**

- Ils sont destinés à placer des grilles ou des canettes EURONORM, 400 x 600 mm.
- Fourni avec 1 grille EN pour chaque porte.
- La profondeur est de 800 mm.
- Il existe des modèles avec plans de travail en acier inoxydable **7** et plans de travail en granit **8**



# MUEBLES PREPARACIÓN PIZZAS CON PUERTAS

E UNITS FOR PREPARING PIZZAS WITH DOORS  
F MEUBLES PRÉPARATION PIZZAS AVEC PORTES

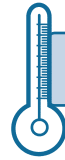

0 +4 °C  
TEMP. +36°C

76V8351X



747202ZQ

EN



GRANIT

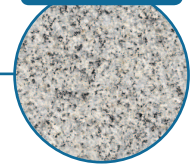

79V8302X



748203ZQ



GRUPO / GROUP / GROUPE 16



GRUPO / GROUP / GROUPE 8

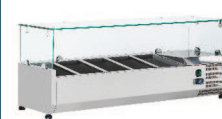

GRUPO / GROUP / GROUPE 11



GAS  
R290



MOD. / COD.								€
747202ZQ	203	1500x800x880	2	2 - 400x600	430	-	400 W - 230/1V	2.450
748203ZQ	296	2025x800x880	3	3 - 400x600	640	-	400 W - 230/1V	2.765



# MUEBLES PREPARACIÓN PIZZAS CON PUERTAS Y CAJONES

E UNITS FOR PREPARING PIZZAS WITH DOORS AND DRAWERS  
 F MEUBLES PRÉPARATION PIZZAS AVEC PORTES ET TIROIRS



76V8351X

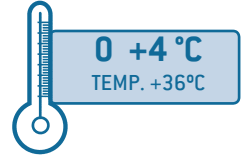

79V8302X



747361ZQ

748362ZQ



7490005D



GRUPO / GROUP / GROUPE 16

GRUPO / GROUP / GROUPE 8

GRUPO / GROUP / GROUPE 11

MOD. / COD.								€
747361ZQ	216	1500x800x880	1	1 - 400x600	220	5	400 W - 230/1V	2.680
748362ZQ	309	2025x800x880	2	2 - 400x600	430	5	400 W - 230/1V	2.975
7490005D	58	525x800x850	-	-	123	5	-	1.075



# REFRIGERADORES DE INGREDIENTES

E INGREDIENT REFRIGERATORS  
F VITRINE À INGRÉDIENTS



▲ 9 GN 1/3 **79V8302X** | 10 GN 1/4 **71V3302X**

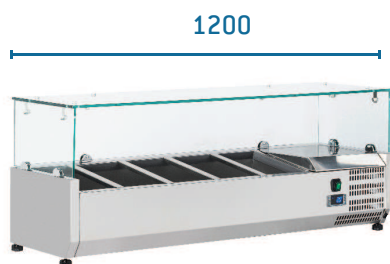
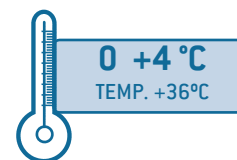

▲ 4 GN 1/3 **74V8321X** | 5 GN 1/4 **75V3321X**



▲ 6 GN 1/3 **76V8351X** | 6 GN 1/4 **76V3341X**



▲ 6 GN 1/3 **76T8351X** | 6 GN 1/4 **76T3341X**



▲ 9 GN 1/3 **79T8302X** | 10 GN 1/4 **71T3302X**

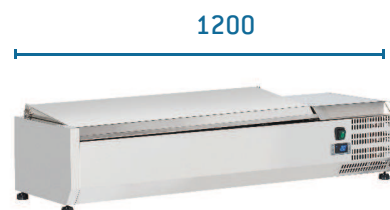

▲ 4 GN 1/3 **74T8321X** | 5 GN 1/4 **75T3321X**



ACCESORIOS  
E ACCESSORIES  
F ACCESSOIRES



▲ COD. PNG71000

OPTIONAL KIT x4



MOD. / COD.					€	
79V8302X	56	2000x395x440	9 - GN 1/3 - 150	*	160 W - 230/1V	1.050
76V8351X	46	1500x395x440	6 - GN 1/3 - 150	*	160 W - 230/1V	915
74V8321X	40	1200x395x440	4 - GN 1/3 - 150	*	160 W - 230/1V	815
79T8302X	34	2000x395x280	9 - GN 1/3 - 150	*	160 W - 230/1V	1.060
76T8351X	29	1500x395x280	6 - GN 1/3 - 150	*	160 W - 230/1V	910
74T8321X	27	1200x395x280	4 - GN 1/3 - 150	*	160 W - 230/1V	835
71V3302X	51	2000x335x440	10 - GN 1/4 - 150	*	160 W - 230/1V	960
76V3341X	41	1400x335x440	6 - GN 1/4 - 150	*	160 W - 230/1V	825
75V3321X	37	1200x335x440	5 - GN 1/4 - 150	*	160 W - 230/1V	750
71T3302X	31	2000x335x280	10 - GN 1/4 - 150	*	160 W - 230/1V	1.030
76T3341X	27	1400x335x280	6 - GN 1/4 - 150	*	160 W - 230/1V	840
75T3321X	25	1200x335x280	5 - GN 1/4 - 150	*	160 W - 230/1V	795

# MESAS FRÍAS DE PASTELERÍA



E PATISSERIE COLD TABLES

F TOURS RÉFRIGÉRÉES PÂTISSERIE

EN-400x600



7M - GRANIT

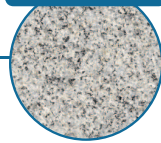

↑ 800 7M0012AP



7I - INOX

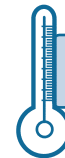

0 +4 °C  
TEMP. +36°C

↑ 800 7I0022AP



↑ 800 7M0013AP



↑ 800 7I0023AP

GAS  
R290



MOD. / COD.					EN			€
7M0012AP	209	1500x800x850	2	2 - 400x600	430	400 W - 230/1V		2.630
7I0022AP	130	1500x800x850	2	2 - 400x600	430	400 W - 230/1V		2.195
7M0013AP	270	2025x800x850	3	3 - 400x600	640	400 W - 230/1V		3.245
7I0023AP	164	2025x800x850	3	3 - 400x600	640	400 W - 230/1V		2.685



G11 P.24/25 CARACTERÍSTICAS GENERALES  
E GENERAL FEATURES F CARACTÉRISTIQUES GÉNÉRALES

CASTerval  
ONLINE

### CONSTRUCCIÓN

- De 700 mm. de profundidad.
- Exterior e interior de acero inoxidable. El trasero es de acero galvanizado.
- Cuba interna con los cantos redondeados para facilitar la limpieza y desagüe en la base. **1**
- Aislamiento de poliuretano inyectado ecológico (libre de CFC), con una densidad de 40 Kgs/m<sup>3</sup> y de 50 mm. de espesor.
- Bisagras de torsión, en todas las puertas. Con posición de mantenimiento abierta, cuando supera los 95 grados. **2**
- Puertas con cierre magnético, mediante burletes dotados de cámara de aire, para asegurar la estanqueidad. Fácilmente sustituibles. **3**
- Las reservas, son GN 1/1, y llevan en dotación una rejilla de 325x530 por puerta. Opcionalmente, se pueden colocar recipientes GN (Ver ACCESORIOS)
- Grupos frigoríficos sobre-dimensionados, situados en la parte inferior del mueble, con desescarche automático. Dichos grupos permiten su extracción para facilitar el servicio de mantenimiento y limpieza del condensador. **4**
- Con frío estático.
- Gas refrigerante hidrocarburo R290 ó R600a (según modelos). De máximo rendimiento para obtener la calificación energética más ecológica, y para reducir las emisiones de CO<sub>2</sub>.
- Temperatura de trabajo 0 +4°C, en conservación, con una temperatura ambiente de +38°C.
- Con termómetro-termostato electrónico digital. Dicho programador permite ajustar las temperaturas, máxima y mínima, con el fin de optimizar al máximo el rendimiento del frigorífico.
- Con interruptor de marcha-paro.
- Con cerradura, situada en la parte inferior de las puertas. **5**
- Con zócalo en la base del mueble y pies regulables.

### MESAS FRÍAS DE CONSERVACIÓN

- Con la encimera de acero inoxidable, con el canto frontal redondeado.

### MESAS FRÍAS DE CONGELACIÓN

- Con la encimera de acero inoxidable, con el canto frontal redondeado.
- Con frío ventilado
- Temperatura de trabajo -18° -22°C, con una temperatura ambiente de +38°C.
- Diseñadas para el mantenimiento de congelados, por lo que el producto se debe introducir previamente congelado.

### MUEBLES DE PREPARACIÓN DE PIZZAS

- Con la encimera de granito.
- Los mod. 74A09PRC y 75A39PRC, tienen un hueco en la parte posterior de la encimera, para colocar opcionalmente, 5 ó 8 recipientes GN 1/6 de 150 mm. de profundidad (ver ACCESORIOS). El frío proviene de la cámara inferior. Así mismo disponen de un estante elevado, que a la vez, cubre los ingredientes. **6**
- El mod. 76A39MRC, se le puede colocar opcionalmente, un refrigerador de ingredientes, de 1.400 mm. de largo, con capacidad para 6 GN 1/4 de 150 mm. de profundidad. Este modelo, la encimera de granito lleva laterales y trasero del mismo material, para soportar el refrigerador, y así disponer de más espacio de trabajo. **7**

### MUEBLES PARA PREPARACIÓN DE BOCADILLOS O SANDWICHES

- La encimera es de acero inoxidable y en la parte posterior, disponen de un hueco elevado 130 mm. de la misma, para colocar opcionalmente, 5 ó 8 recipientes GN 1/6 de 150 mm. de profundidad (ver ACCESORIOS). El frío proviene de la cámara inferior.
- Equipan una tapa abatible, de acero inoxidable, con dos posiciones, abierta o cerrada, de manera que cuando no se usa, los alimentos quedan protegidos higiénicamente y además se mantienen refrigerados. **8**

### MUEBLES PARA PREPARACION DE ENSALADAS O GASTRO-CHEFF

- La encimera está totalmente abierta para colocar, opcionalmente, recipientes GN 1/1, con las combinaciones que deseen. (Ver ACCESORIOS). El frío proviene de la cámara inferior.
- En la parte anterior de la encimera, dispone de una placa de polietileno, para el corte y preparación de las ensaladas.
- Equipan una tapa abatible y telescópica, de acero inoxidable, para tapar los alimentos, cuando no se usa, y a la vez, poder utilizar la encimera, como mesa de trabajo. **9**
- En lugar de tapa, los mod. 77A09QRC y 78A39QRC, disponen de una vitrina cerrada a tres caras, con un estante intermedio de cristal **10**

### ACCESORIOS

- Encontraran una extensa gama de recipientes GN, de acero inoxidable o de policarbonato y rejillas de acero inoxidable o plastificadas.

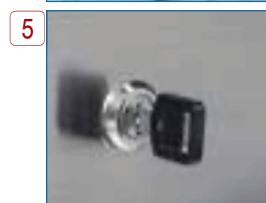

E

**MAKING**

- 700 mm. of depth.
- Exterior and interior in stainless steel. The rear is galvanized steel.
- Internal tank with rounded edges to facilitate cleaning and drainage at the base. **1**
- Ecological injected polyurethane insulation (CFC-free), with a density of 40 Kgs / m<sup>3</sup> and 50 mm. of thickness.
- Torsion hinges on all doors. With open maintenance position, when it exceeds 95 degrees. **2**
- Doors with magnetic closure, by means of weatherstripping with an air chamber, to ensure watertightness. Easily replaceable. **3**
- The reserves are GN 1/1, and have a 325x530 grid per door. Optionally, GN containers can be placed (See ACCESSORIES)
- Oversized refrigerator groups, located at the bottom of the cabinet, with automatic defrost. These groups allow its extraction to facilitate the service of maintenance and cleaning of the condenser. **4**
- With static cold.
- R290 or R600a hydrocarbon refrigerant gas (depending on models). Maximum performance to obtain the most ecological energy rating, and to reduce CO<sub>2</sub> emissions.
- Working temperature 0 +4°C, in conservation, with an ambient temperature of +38°C.
- With digital electronic thermometer-thermostat. This programmer allows adjusting the temperatures, maximum and minimum, in order to maximize the performance of the refrigerator.
- With start-stop switch.
- With lock, located at the bottom of the doors. **5**
- With base at the base of the cabinet and adjustable feet.

**COLD CONSERVATION TABLES**

- With stainless steel worktop, with rounded front edge.

**COLD FREEZING TABLES**

- With stainless steel worktop, with rounded front edge.
- With ventilated cold
- Working temperature -18° -22°C, with an ambient temperature of 38°C.
- Designed for the maintenance of frozen, so the product must be introduced previously frozen.

**FURNITURE FOR PREPARING PIZZA**

- With the granite worktop.
- The mod. 74A09PRC and 75A39PRC, have a hole in the back of the worktop, to optionally place 5 or 8 GN 1/6 150 mm containers. depth (see ACCESSORIES). The cold comes from the lower chamber. They also have a high shelf, which at the same time covers the ingredients. **6**
- The mod. 76A39MRC, it can optionally be fitted with a 1,400 mm ingredient refrigerator. long, with capacity for 6 GN 1/4 of 150 mm. deep. This model, the granite countertop has sides and rear of the same material, to support the refrigerator, and thus have more work space. **7**

**FURNITURE FOR PREPARING SNACKS OR SANDWICHES**

- The worktop is made of stainless steel and at the back they have a 130 mm raised hole. thereof, to optionally place 5 or 8 GN 1/6 150 mm containers. depth (see ACCESSORIES). The cold comes from the lower chamber.
- They are equipped with a flip-top lid, made of stainless steel, with two positions, open or closed, so that when it is not used, food is hygienically protected and it is also kept refrigerated. **8**

**FURNITURE FOR THE PREPARATION OF SALADS OR GASTRO-CHEFF**

- The worktop is fully open to optionally place GN 1/1 containers, with the combinations you want. (See ACCESSORIES). The cold comes from the lower chamber.
- On the front of the counter, it has a polyethylene plate, for cutting and preparing salads.
- They are equipped with a folding and telescopic lid, made of stainless steel, to cover food when not in use, and at the same time, to be able to use the worktop as a work table. **9**
- Instead of a cover, mod. 77A09QRC and 78A39QRC, have a three-sided closed display case, with an intermediate glass shelf **10**

**ACCESSORIES**

- You will find a wide range of GN, stainless steel or polycarbonate containers and stainless steel or plasticized grids.

F

**CONSTRUCTION**

- 700 mm. de profondeur.
- Extérieur et intérieur en acier inoxydable. L'arrière est en acier galvanisé.
- Réservoir interne avec bords arrondis pour faciliter le nettoyage et le drainage à la base. **1**
- Isolation écologique en polyuréthane injecté (sans CFC), d'une densité de 40 Kgs / m<sup>3</sup> et 50 mm. épais.
- La torsion s'articule sur toutes les portes. Avec position de maintenance ouverte, lorsqu'elle dépasse 95 degrés. **2**
- Portes à fermeture magnétique, au moyen de coupe-bise avec chambre à air, pour assurer l'étanchéité. Facilement remplaçable. **3**
- Les réserves sont GN 1/1 et ont une grille 325x530 par porte. En option, des conteneurs GN peuvent être placés (voir ACCESSOIRES)
- Groupes réfrigérants surdimensionnés, situés au bas de le meuble, avec dégivrage automatique. Ces groupes permettent son extraction pour faciliter le service d'entretien et de nettoyage du condenseur. **4**
- Avec froid statique.
- Gaz réfrigérant hydrocarboné R290 ou R600a (selon les modèles). Des performances maximales pour obtenir la cote énergétique la plus écologique et réduire les émissions de CO<sub>2</sub>.
- Température de travail 0 +4°C, en conservation, avec une température ambiante de +38°C.
- Avec thermomètre-thermostat électronique numérique. Ce programmeur permet de régler les températures, maximum et minimum, afin de maximiser les performances du réfrigérateur.
- Avec interrupteur marche-arrêt.
- Avec serrure, située en bas des portes. **5**
- Avec base à la base de l'armoire et pieds réglables.

**TOURS RÉFRIGÉRÉES**

- Avec plan de travail en acier inoxydable, avec bord avant arrondi.

**TOURS RÉFRIGÉRÉES DE CONGÉLATION**

- Avec plan de travail en acier inoxydable, avec bord avant arrondi.
- Avec froid ventilé
- Température de travail -18° -22°C, avec une température ambiante de 38°C.
- Conçu pour l'entretien du surgelé, le produit doit donc être introduit préalablement congelé.

**MEUBLES POUR LA PRÉPARATION DE PIZZA**

- Avec le plan de travail en granit.
- Le mod. 74A09PRC et 75A39PRC, ont un trou à l'arrière le plan de travail, pour placer en option 5 ou 8 récipients GN 1/6 150 mm. profondeur (voir ACCESSOIRES). Le froid vient de la chambre. Ils ont également une étagère haute, qui couvre en même temps les ingrédients. **6**
- Le mod. 76A39MRC, il peut être équipé en option d'un réfrigérateur à ingrédients de 1400 mm. de long, avec une capacité de 6 GN 1/4 de 150 mm. profond. Ce modèle, le plan de travail en granit a des côtés et l'arrière du même matériau, pour soutenir le réfrigérateur, et ainsi avoir plus d'espace de travail. **7**

**MEUBLES POUR LA PRÉPARATION DE SNACKS OU SANDWICHES**

- Le plan de travail est en acier inoxydable et à l'arrière, il a un trou surélevé de 130 mm. de celui-ci, pour placer éventuellement 5 ou 8 conteneurs GN 1/6 150 mm. profondeur (voir ACCESSOIRES). Le froid vient de la chambre.
- Ils sont équipés d'un couvercle rabattable, en acier inoxydable, à deux positions, ouvert ou fermé, de sorte que lorsqu'ils ne sont pas utilisés, les aliments sont hygiéniquement protégés et restent également réfrigérés. **8**

**MEUBLES POUR LA PRÉPARATION DE SALADES OU GASTRO-CHEFF**

- Le plan de travail est entièrement ouvert pour placer éventuellement des conteneurs GN 1/1, avec les combinaisons que vous souhaitez. (Voir ACCESSOIRES). Le froid vient de la chambre.
- Sur le devant le plan de travail, il a une plaque en polyéthylène, pour couper et préparer des salades.
- Ils sont équipés d'un couvercle pliant et télescopique en acier inoxydable pour couvrir les aliments lorsqu'ils ne sont pas utilisés, et en même temps pour pouvoir utiliser le plan de travail comme table. **9**
- Au lieu d'une couverture, le mod. 77A09QRC et 78A39QRC, ont une vitrine fermée à trois côtés, avec une étagère en verre intermédiaire **10**

**ACCESSOIRES**

- Vous trouverez une large gamme de bacs GN, inox ou polycarbonate et grilles inox ou plastifiées.



- E COLD TABLES WITH BLIND DOORS
- F TOURS RÉFRIGÉRÉES À PORTES INOX

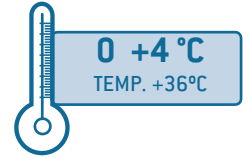

↗ 700 70A09XRC

GAS  
R600A



↗ 700 70A39XRC

GAS  
R290



MOD. / COD.							€
70A09XRC	87	900x700x880	2	2 - GN 1/1	230	300W - 230/1V	1.280
70A39XRC	106	1365x700x880	3	3 - GN 1/1	350	300W - 230/1V	1.670





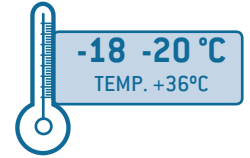

700 70V39XNC



**SON PARA MANTENIMIENTO DE CONGELADOS.  
EL PRODUCTO DEBE ESTAR PREVIAMENTE CONGELADO.**

- E THEY ARE FOR FROZEN MAINTENANCE.  
THE PRODUCT MUST BE PREVIOUSLY FROZEN.
- F ILS SONT POUR L'ENTRETIEN SURGÉLÉ.  
LE PRODUIT DOIT ÊTRE PRÉCÉDEMMENT CONGÉLÉ.

MOD. / COD.							
70V39XNC	115	1385x700x880	3	3 - GN 1/1	370	400W - 230/1V	2.205



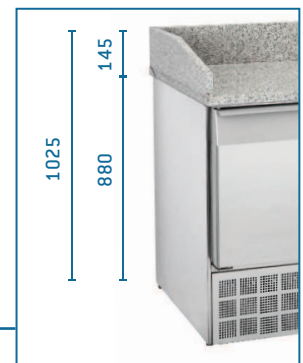
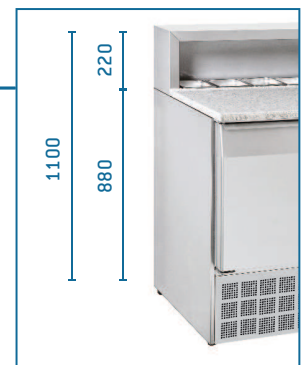
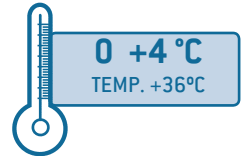

MOD. / COD.							€
74A09PRC	110	900x700x880	2	2 - GN 1/1	230	300 W - 230/1V	1.340
75A39PRC	145	1365x700x880	3	3 - GN 1/1	350	300 W - 230/1V	2.040
76A39MRC	200	1400x700x880	3	3 - GN 1/1	350	300 W - 230/1V	1.885



5 GN-1/6-150\*

▲ 72A09SRC

GAS  
R600a

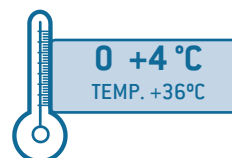

8 GN-1/6-150\*



▲ 73A39SRC

GAS  
R290

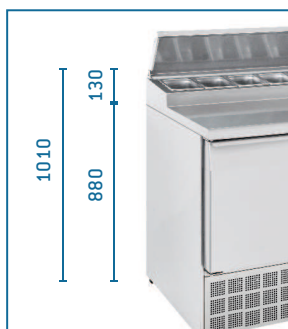

MOD. / COD.							€
72A09SRC	95	900x700x880	2	2 - GN 1/1	240	300 W - 220/1V	1.455
73A39SRC	112	1365x700x880	3	3 - GN 1/1	390	300 W - 220/1V	1.945





- E SALAD PREPARING UNITS – GASTRO CHEFF
- F MEUBLES DE PRÉPARATION DE SALADES / GASTRO-CHEFF

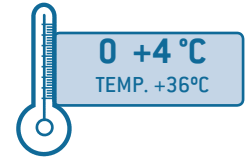

1/1	1/4	1/1	*	1/1	1/6	1/2
	1/4				1/6	1/2

**701A09RC** GAS R600a

1/1	1/2	1/2	1/1	*	1/1	1/2	1/3	1/2
	1/2	1/2				1/2	1/3	1/2



**702A39RC** GAS R290



MOD. / COD.							€
701A09RC	86	900x700x880	2	2 - GN 1/1	230	300 W - 220/1V	1.235
702A39RC	102	1365x700x880	3	3 - GN 1/1	350	300 W - 220/1V	1.675



E UNITS FOR PREPARING SALADS WITH VITRINE  
F MEUBLES PREPARATION DE SALADES AVEC VITRINE



1/1	1/4	1/1
	1/4	

\*

1/1	1/6	1/2
	1/6	1/2
	1/6	1/2

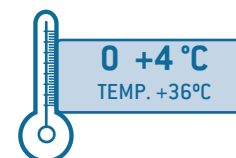

77A09QRC

GAS  
R600a

1/1	1/2	1/2	1/1
	1/2	1/2	

\*

1/1	1/2	1/3	1/2
	1/2	1/3	1/2
		1/3	



78A39QRC

GAS  
R290



MOD. / COD.							€
77A09QRC	97	900x700x1300	2	2 - GN 1/1	230	300 W - 220/1V	1.670
78A39QRC	125	1365x700x1300	3	3 - GN 1/1	350	300 W - 220/1V	2.230



## CONSTRUCCIÓN

- Exterior e interior en acero inoxidable AISI-304, 18/10. Los traseros son de acero galvanizado.
- Cubas internas con los cantos redondeados **1** para facilitar la limpieza y desagüe en la base.
- Aislamiento de poliuretano inyectado ecológico (libre de CFC), con una densidad de 40 Kgs./m<sup>3</sup>, de 70 mm de espesor.
- Con patas de acero inoxidable, regulables en altura de 125 a 200 mm. Se pueden substituir por ruedas (Ver ACCESORIOS)
- Bisagras de torsión en todas las puertas. Con posición de mantenimiento abierta, cuando supera los 95° **2**
- Puertas con tirador incorporado, con cierre magnético, mediante burletes dotados de cámara de aire, para asegurar la estanqueidad. Fácilmente sustituibles. **3**
- Puertas con apertura reversible. **4**
- Con luz interior.
- Grupos frigoríficos sobre-dimensionados, con descarche automático.
- Frio ventilado para conseguir la temperatura homogénea en el interior. **5**
- Gas refrigerante hidrocarburo R290. De máximo rendimiento para obtener la calificación energética más ecológica, y para reducir las emisiones de CO<sub>2</sub>.
- Temperatura de trabajo 0 + 4°C, en conservación y -18° - 22°C en los armarios de mantenimiento de congelados, con una temperatura ambiente de +38°C.
- Con termómetro-termostato electrónico digital. Dicho programador permite ajustar las temperaturas máxima y mínima, así como los descarches, automáticamente, con el fin de optimizar el máximo rendimiento del frigorífico.
- Con interruptor luminoso de marcha-paro.

## ARMARIOS CON PUERTAS DE CRISTAL

- Con cristal doble con cámara de aire. **6**
- Con cerradura en las puertas.

## ARMARIOS SERIE 5

- De fondo 720 mm., para su instalación en espacios reducidos.
- Con el grupo frigorífico colocado en la parte inferior.
- Rejillas de varilla plastificada, regulables en altura cada 70 mm., mediante una cremallera. Con dotación de 3 unidades por cuerpo. Opcionalmente se pueden suministrar soportes para colocar más rejillas. (Ver ACCESORIOS).
- Se fabrican los modelos mixtos, los cuales disponen de un compartimento estanco, cuyo frío es estático. Para pescado, o mantenimiento de congelados. Siempre en una puerta pequeña en la parte inferior. Con dotación de 3 cajones de PVC, con doble fondo perforado de acero inox. (De 530x460x100) **7**

## ARMARIOS SERIE 8

- Con el grupo frigorífico en la parte superior.
- Con guías, en forma de "U", para la colocación de las rejillas, a la altura deseada. Con dotación de 3 unidades por cuerpo. Opcionalmente se pueden suministrar más pares de guías y rejillas plastificadas o de acero inox., al igual que recipientes (Ver ACCESORIOS)
- Se fabrican para, GN 1/1, cuyo ancho son 490 mm, ideales para cocinas pequeñas, y de 700 mm de fondo.
- También para GN 2/1, o para pastelería EN 400x600 de fondo 820 mm.

## ARMARIOS SERIE 8 PARA PESCADO

- Con el grupo frigorífico en la parte superior.
- Con un sistema de distribución del frío interior, diseñado para ofrecer una alta humedad.
- De fondo 720 mm, solamente, al introducir los cajones por el lado de 600 mm.
- Con 7 cajones de PVC, en dotación de 600x400x120, con doble fondo perforado de acero inox. **8**

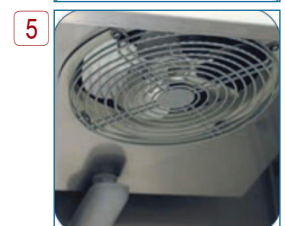

**MAKING**

- Outside and inside in AISI-304, 18/10 stainless steel. The rear ones are made of galvanized steel.
- Internal tanks with rounded edges **1** to facilitate cleaning and drainage at the base.
- Ecological injected polyurethane insulation (CFC-free), with a density of 40 Kgs./m<sup>3</sup>, 70 mm thick.
- With stainless steel legs, adjustable in height from 125 to 200 mm. They can be replaced by wheels (See ACCESSORIES)
- Torsion hinges on all doors. With open maintenance position, when it exceeds 95° **2**
- Doors with built-in handle, with magnetic closure, by means of weatherstripping with an air chamber, to ensure watertightness. Easily replaceable. **3**
- Doors with reversible opening. **4**
- With interior light.
- Oversized refrigerator groups, with automatic defrost.
- Cold ventilated to achieve a homogeneous temperature inside. **5**
- R290 hydrocarbon refrigerant gas. Maximum performance to obtain the most ecological energy rating, and to reduce CO<sub>2</sub> emissions.
- Working temperature 0 + 4°C, in storage and -18° - 22°C in frozen storage cabinets, with an ambient temperature of + 38°C.
- With digital electronic thermometer-thermostat. This programmer allows adjusting the maximum and minimum temperatures, as well as the defrosts, automatically, in order to optimize the maximum performance of the refrigerator.
- With light start-stop switch.

**CABINETS WITH GLASS DOORS**

- With double glass with air chamber. **6**
- With lock on the doors.

**SERIES 5 CABINETS**

- 720 mm depth, for installation in small spaces.
- With the refrigeration unit placed at the bottom.
- Plasticized rod grids, adjustable in height every 70 mm., By means of a zipper. With 3 units per body. Optionally supports can be supplied to place more grids. (See ACCESSORIES).
- Mixed models are manufactured, which have a watertight compartment, whose cold is static. For fish, or frozen maintenance. Always in a small door at the bottom. With 3 PVC drawers, with a double perforated stainless steel bottom. (From 530x460x100) **7**

**SERIES 8 CABINETS**

- With the refrigeration unit at the top.
- With guides, in the form of "U", for the placement of the grids, at the desired height. With 3 units per body. Optionally, more pairs of guides and plasticized or stainless steel grids can be supplied, as well as containers (See ACCESSORIES)
- They are manufactured for GN 1/1, whose width is 490 mm, ideal for small kitchens, and 700 mm deep.
- Also for GN 2/1, or for pastry EN 400x600 with 820 mm depth.

**SERIES 8 CABINETS FOR FISH**

- With the refrigeration unit at the top.
- With an internal cold distribution system, designed to offer high humidity.
- 720 mm depth only, when introducing the drawers on the 600 mm side.
- With 7 PVC drawers, supplied 600x400x120, with double perforated stainless steel bottom. **8**

**CONSTRUCTION**

- Extérieur et intérieur en AISI-304, acier inoxydable 18/10. Les arrières sont en acier galvanisé.
- Réservoirs internes à bords arrondis **1** pour faciliter le nettoyage et le drainage à la base.
- Isolation écologique en polyuréthane injecté (sans CFC), d'une densité de 40 Kgs./m<sup>3</sup>, 70 mm d'épaisseur.
- Avec pieds en acier inoxydable, réglables en hauteur de 125 à 200 mm. Ils peuvent être remplacés par des roues (voir ACCESSOIRES)
- La torsion s'articule sur toutes les portes. Avec position de maintenance ouverte, lorsqu'elle dépasse 95° **2**
- Portes avec poignée intégrée, à fermeture magnétique, au moyen de coupe-bise munis d'une chambre à air, pour assurer l'étanchéité. Facilement remplaçable. **3**
- Portes à ouverture réversible. **4**
- Avec lumière intérieure.
- Groupes réfrigérants surdimensionnés, avec dégivrage automatique.
- Froid ventilé pour atteindre une température homogène à l'intérieur. **5**
- Gaz réfrigérant hydrocarboné R290. Des performances maximales pour obtenir la cote énergétique la plus écologique et réduire les émissions de CO<sub>2</sub>.
- Température de travail 0 + 4°C, en stockage et -18° - 22°C en armoires de stockage congelées, avec une température ambiante de + 38°C.
- Avec thermomètre-thermostat électronique numérique. Ce programmeur permet d'ajuster automatiquement les températures maximales et minimales, ainsi que les dégivrages, afin d'optimiser les performances maximales du réfrigérateur.
- Avec interrupteur marche / arrêt léger.

**ARMOIRES AVEC PORTES EN VERRE**

- Avec double vitrage avec chambre à air. **6**
- Avec serrure sur les portes.

**ARMOIRES SÉRIE 5**

- 720 mm de profondeur, pour une installation dans de petits espaces.
- Avec l'unité de réfrigération placée en bas.
- Grilles de tige plastifiées, réglables en hauteur tous les 70 mm., Au moyen d'une fermeture éclair. Avec 3 unités par corps. En option, des supports peuvent être fournis pour placer plus de grilles. (Voir ACCESSOIRES).
- Des modèles mixtes sont fabriqués, qui ont un compartiment étanche, dont le froid est statique. Pour le poisson ou l'entretien surgelé. Toujours dans une petite porte en bas. Avec 3 tiroirs en PVC, avec un fond en acier inoxydable double perforé. (À partir de 530x460x100) **7**

**ARMOIRES SÉRIE 8**

- Avec le groupe réfrigérateur en haut.
- Avec guides, en forme de "U", pour le placement des grilles, à la hauteur souhaitée. Avec 3 unités par corps. En option, plus de paires de guides et de grilles plastifiées ou en acier inoxydable peuvent être fournies, ainsi que des conteneurs (voir ACCESSOIRES)
- Ils sont faits pour GN 1/1, dont la largeur est de 490 mm, idéale pour les petites cuisines, et 700 mm de profondeur.
- Aussi pour GN 2/1, ou pour pâtisserie EN 400x600 avec 820 mm de profondeur.

**ARMOIRES SÉRIE 8 POUR POISSONS**

- Avec le groupe réfrigérateur en haut.
- Avec un système de distribution de froid intérieur, conçu pour offrir une humidité élevée.
- Profondeur 720 mm, uniquement, lors de l'introduction des tiroirs côté 600 mm.
- Avec 7 tiroirs en PVC, fournis 600x400x120, avec un fond en acier inoxydable double perforé. **8**

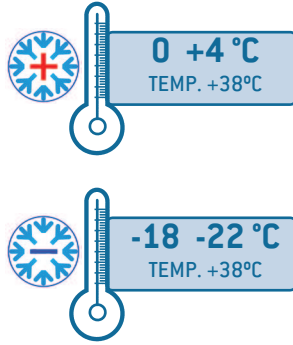

**SON PARA MANTENIMIENTO DE CONGELADOS.  
EL PRODUCTO DEBE ESTAR PREVIAMENTE CONGELADO.**

- E THEY ARE FOR FROZEN MAINTENANCE.  
THE PRODUCT MUST BE PREVIOUSLY FROZEN.
- F ILS SONT POUR L'ENTRETIEN SURGELÉ.  
LE PRODUIT DOIT ÊTRE PRÉCÉDEMMENT CONGELÉ.

MOD. / COD.								€
78810609	120	700x720x2070	1	3 - 560x542	600		300 W - 230/1V	2.005
79810609	122	700x720x2070	2	3 - 560x542	600		300 W - 230/1V	2.050
79020609	124	700x720x2070	1	3 - 560x542	600		700 W - 230/1V	2.690
72120609	126	700x720x2070	2	3 - 560x542	600		700 W - 230/1V	2.805



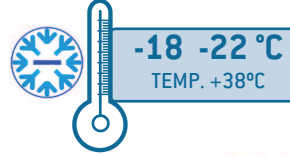
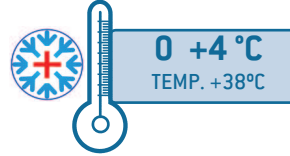

74020609 73120609

76020609 76120609



**SON PARA MANTENIMIENTO DE CONGELADOS.  
EL PRODUCTO DEBE ESTAR PREVIAMENTE CONGELADO.**

- E THEY ARE FOR FROZEN MAINTENANCE.  
THE PRODUCT MUST BE PREVIOUSLY FROZEN.
- F ILS SONT POUR L'ENTRETIEN SURGELÉ.  
LE PRODUIT DOIT ÊTRE PRÉCÉDEMMENT CONGELÉ.

MOD. / COD.								€
74020609	180	1400x720x2070	2	6 - 560x542	1200		400 W - 230/1V	2.730
76020609	184	1400x720x2070	4	6 - 560x542	1200		400 W - 230/1V	2.840
73120609	187	1400x720x2070	2	6 - 560x542	1200		1200 W - 230/1V	3.680
76120609	191	1400x720x2070	4	6 - 560x542	1200		1200 W - 230/1V	3.820



E REFRIGERATED EXHIBITORS 720 WITH GLASS DOORS

F ARMOIRES FRIGORIFIQUES 720 AVEC PORTES EN VERRE

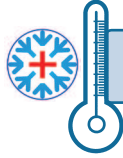

0 +4 °C  
TEMP. +38°C



72020609



77020609



MOD. / COD.								€
72020609	123	700x720x2070	1	3 - 560x542	600		300 W - 230/1V	2.260
77020609	183	1200x720x2070	2	6 - 560x542	1200		400 W - 230/1V	3.320



E 720 MIXED REFRIGERATOR CABINETS WITH FISH DEPARTMENT  
 F ARMOIRES FRIGORIFIQUES MIXTES FONDS 720 AVEC DÉPARTEMENT DU POISSON

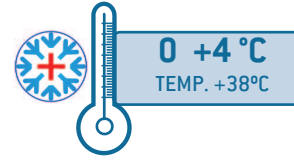

77120609



79120609

**ACCESORIOS**  
 E ACCESSORIES  
 F ACCESSOIRES

**COD. 97741091**

SERIAL 3 UNID.

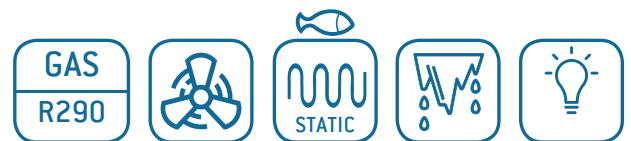

MOD. / COD.								€
77120609	127	700x720x2070	2	1 - 560x542	600		300 W - 230/1V	2.930
79120609	189	1400x720x2070	3	4 - 560x542	1200		400 W - 230/1V	3.645



E 720 MIXED REFRIGERATOR CABINETS WITH FROZEN DEPARTMENT

F ARMOIRES FRIGORIFIQUES MIXTES FONDS 720 AVEC DÉPARTEMENT CONGELÉ

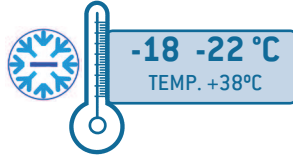
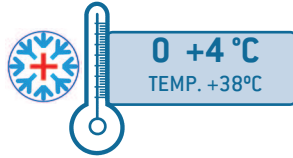

70220609



78120609

**ACCESORIOS**  
E ACCESSORIES  
F ACCESSOIRES

100  
530  
460

COD. 97741091

SERIAL 3 UNID.



**SON PARA MANTENIMIENTO DE CONGELADOS.  
EL PRODUCTO DEBE ESTAR PREVIAMENTE CONGELADO.**

- E THEY ARE FOR FROZEN MAINTENANCE.  
THE PRODUCT MUST BE PREVIOUSLY FROZEN.
- F ILS SONT POUR L'ENTRETIEN SURGELÉ.  
LE PRODUIT DOIT ÊTRE PRÉCÉDEMMENT CONGELÉ.

**GAS**  
R290

MOD. / COD.								€
78120609	131	700x720x2070	2	1 - 560x542	600		700 W - 230/1V	3.280
70220609	196	1400x720x2070	3	4 - 560x542	1200		900 W - 230/1V	3.995

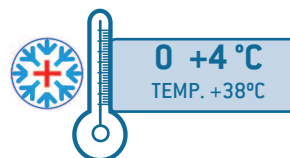

▲ 70899509

GAS R290 SERIAL

ACCESORIOS  
E ACCESSORIES  
F ACCESSOIRES

▲ 60874109  
SERIAL 7 UNID.

MOD. / COD.							€
70899509	138	760x720x2010	1	600		600 W - 230/1V	2.660

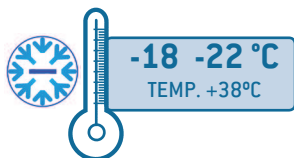
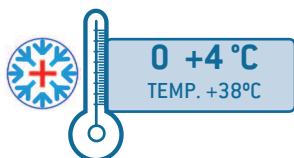
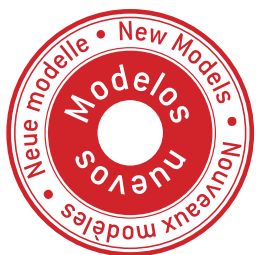

72774109



73774109

GAS  
R600A



79880609



**SON PARA MANTENIMIENTO DE CONGELADOS.  
EL PRODUCTO DEBE ESTAR PREVIAMENTE CONGELADO.**

- E THEY ARE FOR FROZEN MAINTENANCE.  
THE PRODUCT MUST BE PREVIOUSLY FROZEN.
- F ILS SONT POUR L'ENTRETIEN SURGELÉ.  
LE PRODUIT DOIT ÊTRE PRÉCÉDEMMENT CONGELÉ.

MOD. / COD.								€
72774109	110	470x700x2010	1	3 - 325x530 GN 1/1	325		300 W - 230/1V	1.850
73774109	114	470x700x2010	1	3 - 325x530 GN 1/1	325		700 W - 230/1V	2.370
79880609	112	470x700x2010	1	3 - 325x530 GN 1/1	325		300 W - 230/1V	2.125

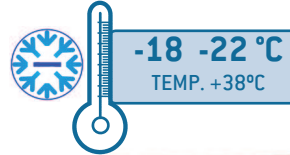
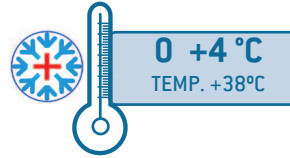

73399509 74699509

74399509 76699509



SON PARA MANTENIMIENTO DE CONGELADOS.  
EL PRODUCTO DEBE ESTAR PREVIAMENTE CONGELADO.

- E THEY ARE FOR FROZEN MAINTENANCE.  
THE PRODUCT MUST BE PREVIOUSLY FROZEN.
- F ILS SONT POUR L'ENTRETIEN SURGELÉ.  
LE PRODUIT DOIT ÊTRE PRÉCÉDEMMENT CONGELÉ.



MOD. / COD.								€
73399509	123	700x820x2010	1	3 - 530x650 GN 2/1	700		300 W - 230/1V	2.250
74399509	125	700x820x2010	2	3 - 530x650 GN 2/1	700		300 W - 230/1V	2.300
74699509	127	700x820x2010	1	3 - 530x650 GN 2/1	700		700 W - 230/1V	3.015
76699509	129	700x820x2010	2	3 - 530x650 GN 2/1	700		700 W - 230/1V	3.070

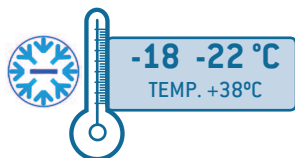
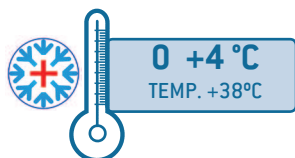
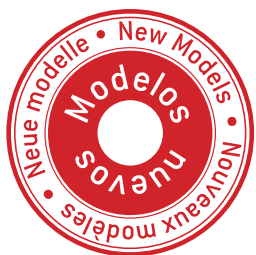

77399509 77699509

79399509 78699509



**SON PARA MANTENIMIENTO DE CONGELADOS.  
 EL PRODUCTO DEBE ESTAR PREVIAMENTE CONGELADO.**

- E THEY ARE FOR FROZEN MAINTENANCE.  
THE PRODUCT MUST BE PREVIOUSLY FROZEN.
- F ILS SONT POUR L'ENTRETIEN SURGELÉ.  
LE PRODUIT DOIT ÊTRE PRÉCÉDEMMENT CONGELÉ.

MOD. / COD.								€
77399509	183	1400x820x2010	2	6 - 530x650 GN 2/1	1400		400 W - 230/1V	3.415
79399509	187	1400x820x2010	4	6 - 530x650 GN 2/1	1400		400 W - 230/1V	3.490
77699509	191	1400x820x2010	2	6 - 530x650 GN 2/1	1400		1200 W - 230/1V	4.295
78699509	195	1400x820x2010	4	6 - 530x650 GN 2/1	1400		1200 W - 230/1V	4.340





E 820 GN 2/1 REFRIGERATOR CABINETS WITH GLASS DOORS  
 F ARMOIRES FRIGORIFIQUES FONDS 820 AVEC PORTES VITRÉES GN 2/1

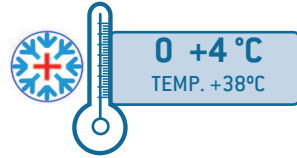

76399509



72699509



MOD. / COD.								€
76399509	125	700x820x2010	1	3 - 530x650 GN 2/1	700		300 W - 230/1V	2.475
72699509	187	1400x820x2010	2	3 - 530x650 GN 2/1	1400		400 W - 230/1V	3.540

### CONSTRUCCIÓN

- Exterior en acero inoxidable. Trasero en acero galvanizado.
- Cuba interna color blanco, en material sanitario ABS, **1** con los cantos redondeados y desagüe inferior.
- Aislamiento de poliuretano inyectado ecológico (libre de CFC), con una densidad de 40 Kgs./m<sup>3</sup>, de 50 mm de espesor.
- Con pies regulables.
- Puerta reversible, con cierre magnético, mediante burletes dotados de cámara de aire, para asegurar la estanqueidad. Fácilmente sustituibles. **2**
- Dotados de cerradura. **3**
- Frio estático, en todos los modelos, y desescarche manual.
- Grupo frigorífico situado en la parte inferior-posterior.
- Con termómetro-termostato electrónico digital, que permite ajustar las temperaturas deseadas, máxima y mínima. **4**
- Con interruptor luminoso de marcha-paro.

### ARMARIOS DE CONSERVACIÓN

- Temperatura de trabajo 0° + 4°C, con una temperatura ambiente de +36°C.
- Gas refrigerante hidrocarburo R600a. de máximo rendimiento para obtener la calificación energética mas ecológica, y para reducir emisiones de CO<sub>2</sub>.
- Con rejillas extraíbles, que se pueden colocar en distintas alturas, en las guías de que disponen los laterales de ABS. **5**
- En el modelo de 600 litros, se pueden colocar recipientes GN 2/1 ó hasta 6 cajones para pescado **6**. En este supuesto, deben ir encima de una rejilla.

### ARMARIOS DE CONGELACIÓN

- Temperatura de trabajo -18° - 22°C, con una temperatura ambiente de + 36°C.
- Gas refrigerante hidrocarburo R404, escepto el mod. de 200 litros, que es R290 de máximo rendimiento para obtener la calificación energética mas ecológica, y para reducir las emisiones de CO<sub>2</sub>.
- Con rejillas evaporadoras fijas. **7**
- En el modelo de 600 litros, se puede colocar el KIT de cestos, para la mejor clasificación del producto. **8**

### ARMARIOS CON PUERTA DE CRISTAL

- Equipados con luz interior
- Los modelos de CONSERVACION, tienen la puerta con cristal doble y cámara de aire.
- Los modelos de CONGELACION, tienen la puerta con cristal triple y cámaras de aire. Además equipan una resistencia anti-vaho.

### VER ACCESORIOS

- Donde encontrarán recipientes GN, cestos, rejillas etc.

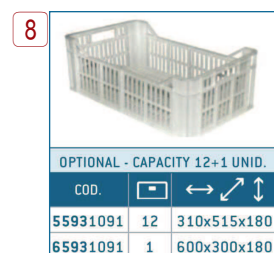
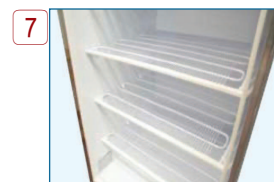
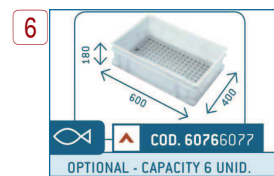
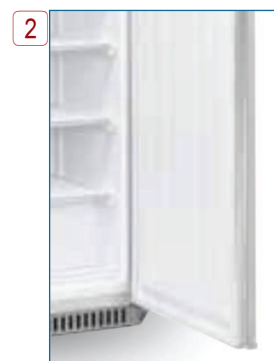

E

**MAKING**

- Exterior in stainless steel. Rear in galvanized steel.
- White internal tank, in ABS sanitary material, **1** with rounded edges and bottom drain.
- Ecological injected polyurethane insulation (CFC-free), with a density of 40 Kgs./m<sup>3</sup>, 50 mm thick.
- With adjustable feet.
- Reversible door, with magnetic closure, by means of weatherstripping provided with an air chamber, to ensure watertightness. Easily replaceable. **2**
- Equipped with a lock. **3**
- Static cold, on all models, and manual defrost.
- Refrigeration unit located at the bottom-rear.
- With digital electronic thermometer-thermostat, which allows adjusting the desired temperatures, maximum and minimum. **4**
- With light start-stop switch.

**CONSERVATION CABINETS**

- Working temperature 0° + 4°C, with an ambient temperature of + 36°C.
- Hydrocarbon refrigerant gas R600a. of maximum performance to obtain the most ecological energy rating, and to reduce CO<sub>2</sub> emissions.
- With removable grids, which can be placed at different heights, in the guides that have the ABS sides. **5**
- In the 600-liter model, GN 2/1 containers or up to 6 fish drawers can be placed. **6**. In this case, they must be on top of a rack.

**FREEZING CABINETS**

- Working temperature -18° - 22°C, with an ambient temperature of + 36°C.
- Hydrocarbon refrigerant gas R404, except mod. 200 liters, which is R290 of maximum performance to obtain the most ecological energy rating, and to reduce CO<sub>2</sub> emissions.
- With fixed evaporating grids. **7**
- In the 600 liter model, the basket KIT can be placed, for the best classification of the product. **8**

**CABINETS WITH GLASS DOOR**

- Equipped with interior light
- CONSERVATION models have a double glass door and an air chamber.
- FREEZING models have a triple glazed door and air chambers. They also have an anti-fog resistance.

**SEE ACCESSORIES**

- Where you will find GN containers, baskets, racks etc.

F

**CONSTRUCTION**

- Extérieur en acier inoxydable. Arrière en acier galvanisé.
- Réservoir intérieur blanc, en matériau sanitaire ABS, **1** avec bords arrondis et vidange inférieure.
- Isolation écologique en polyuréthane injecté (sans CFC), d'une densité de 40 Kgs./m<sup>3</sup>, 50 mm d'épaisseur.
- Avec pieds réglables.
- Porte réversible, à fermeture magnétique, par coupe-bise avec chambre à air, pour assurer l'étanchéité. Facilement remplaçable. **2**
- Equipé d'une serrure. **3**
- Froid statique, sur tous les modèles, et dégivrage manuel.
- Unité de réfrigération située en bas à l'arrière.
- Avec thermomètre-thermostat électronique numérique, qui permet de régler les températures souhaitées, maximum et minimum. **4**
- Avec interrupteur marche / arrêt léger.

**ARMOIRES DE CONSERVATION**

- Température de travail 0° + 4°C, avec une température ambiante de + 36°C.
- Gaz réfrigérant hydrocarbure R600a. de performances maximales pour obtenir la cote énergétique la plus écologique et réduire les émissions de CO<sub>2</sub>.
- Avec des grilles amovibles, qui peuvent être placées à différentes hauteurs, dans les guides qui ont les côtés ABS. **5**
- Dans le modèle de 600 litres, des récipients GN 2/1 ou jusqu'à 6 tiroirs à poisson peuvent être placés **6**. Dans ce cas, ils doivent être placés sur une grille.

**ARMOIRES DE CONGÉLATION**

- Température de travail -18° - 22°C, avec une température ambiante de + 36°C.
- Gaz réfrigérant hydrocarbure R404, sauf mod. 200 litres, ce qui est du R290 de performances maximales pour obtenir la cote énergétique la plus écologique et réduire les émissions de CO<sub>2</sub>.
- Avec grilles d'évaporation fixes. **7**
- Dans le modèle 600 litres, le KIT panier peut être placé, pour la meilleure classification du produit. **8**

**ARMOIRES AVEC PORTE EN VERRE**

- Equipé de lumière intérieure
- Les modèles CONSERVATION ont une double porte vitrée et une chambre à air.
- Les modèles FREEZING ont une porte à triple vitrage et des chambres à air. Ils ont également une résistance anti-buée.

**VOIR LES ACCESSOIRES**

- Où vous trouverez des conteneurs GN, des paniers, des grilles, etc.

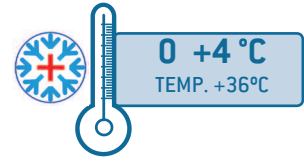

▲ 72PI152S



▲ 74PI154S

▲ 76PI156S GN 2/1

**ACCESORIOS**  
E ACCESSORIES  
F ACCESSOIRES

▲ COD. 60766077  
OPTIONAL - CAPACITY 6 UNID.

**GAS**  
R600A

**STATIC**

**SERIAL**

MOD. / COD.				DOT				€
72PI152S	43	630x600x850	1	3	507x415	150	100 W - 230/1V	905
74PI154S	72	630x740x1870	1	3 1	507x415 507x225	400	150 W - 230/1V	1.170
76PI156S	90	780x740x1870	1	3 1	650x525 650x330	600	200 W - 230/1V	1.450



72NI152S



74NI154S

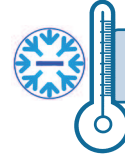

-18 -22 °C  
TEMP. +36°C

EXTERIOR DE ACERO INOXIDABLE  
OUTDOOR STAINLESS STEEL ACIER  
INOXYDABLE POUR EXTERIEUR



76NI156S



ACCESORIOS  
E ACCESSORIES  
F ACCESSOIRES



OPTIONAL - CAPACITY 12+1 UNID.

COD.	■	↔ ↗ ↕
55931091	12	310x515x180
65931091	1	600x300x180



SON PARA MANTENIMIENTO DE CONGELADOS.  
EL PRODUCTO DEBE ESTAR PREVIAMENTE CONGELADO.

- E THEY ARE FOR FROZEN MAINTENANCE.  
THE PRODUCT MUST BE PREVIOUSLY FROZEN.
- F ILS SONT POUR L'ENTRETIEN SURGELÉ.  
LE PRODUIT DOIT ÊTRE PRÉCÉDEMMENT CONGELÉ.

MOD. / COD.	👤	↔ ↗ ↕	📱	📏 FIXED	📏	🌀	€
72NI152S	45	630x600x850	1	3	150	100 W - 230/1V	965
74NI154S	74	630x740x1870	1	7	400	150 W - 230/1V	1.325
76NI156S	94	780x740x1870	1	7	600	200 W - 230/1V	1.730



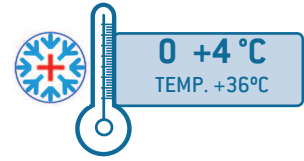

72PC002G

EXTERIOR DE ACERO INOXIDABLE  
OUTDOOR STAINLESS STEEL ACIER  
INOXYDABLE POUR EXTERIEUR



76PC156S

74PC154S



MOD. / COD.							€
72PC002G	46	600x670x840	1	2	200	130 W - 230/1V	855
74PC154S	79	630x740x1870	1	3 - 507x415 1 - 507x225	400	200 W - 230/1V	1.300
76PC156S	116	780x740x1870	1	3 - 650x525 1 - 650x330	600	200 W - 230/1V	1.515



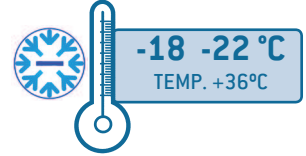

EXTERIOR DE ACERO INOXIDABLE  
OUTDOOR STAINLESS STEEL ACIER  
INOXYDABLE POUR EXTERIEUR

72NC002G

GAS  
R290



74NC104S

GAS  
R404



76NC106S

GAS  
R404



SON PARA MANTENIMIENTO DE CONGELADOS.  
EL PRODUCTO DEBE ESTAR PREVIAMENTE CONGELADO.

E THEY ARE FOR FROZEN MAINTENANCE.  
THE PRODUCT MUST BE PREVIOUSLY FROZEN.

F ILS SONT POUR L'ENTRETIEN SURGELÉ.  
LE PRODUIT DOIT ÊTRE PRÉCÉDEMMENT CONGELÉ.

MOD. / COD.							€
72NC002G	48	600x670x840	1	2	200	130 W - 230/1V	1.220
74NC104S	82	630x740x1870	1	7	400	200 W - 230/1V	1.635
76NC106S	119	780x740x1870	1	7	600	200 W - 230/1V	1.975



## ¿QUE ES UN ABATIDOR?

- Es un "Armario frigorífico para conservación (+) o congelación (-), con un grupo muy potente"
- Los abatidores, impiden la reproducción de los microorganismos, en la comidas recién preparadas. La manera tradicional de conservar los alimentos cocinados, era dejar que el producto se enfriara, a temperatura ambiente, hasta que alcanzara una temperatura adecuada, para colocarlo en un refrigerador. En esas condiciones, en el alimento se desencadena una notable proliferación bacteriana.
- Con un abatidor, se ahorra tiempo, ya que la preparación adelantada de los alimentos y el abatimiento, permiten al cocinero, ofrecer, cuando es preciso un menú mas variado. Con la simple operación de regeneración de la comida, es posible servir en muy poco tiempo, muchos mas platos.
- Un producto recién cocinado y abatido, se puede introducir a + 90° C, puede ser consumido entre 5 y 7 días. Y si se congela, la duración del producto puede alcanzar varios meses.
- Según el tamaño del abatidor, varían los kilos de producto que se pueden abatir, en temperatura de conservación o de congelación.
- Así mismo la duración del ciclo, son 90 minutos de +90° a +3° C, y 240 minutos de +90° a -18° C.

## CONSTRUCCIÓN

- Exterior e interior en acero inoxidable 18/10 AISI-304.
- Cuba interna con los cantos redondeados, para facilitar la limpieza, y desagüe en la base.
- Guías laterales para las rejillas, desmontables con la mano. Aptos para GN ó EN. Separación entre ellas de 65 mm. **1**
- Aislamiento de poliuretano inyectado ecológico, (libre de CFC), con una densidad de 42 Kgs./ m3 y de 60/80 mm de espesor, según modelo.
- Con patas de acero inoxidable.
- Bisagras de torsión, que permiten la apertura hasta 180°, con sistema de retorno automático.
- Puerta con tirador incorporado, con cierre magnético, mediante burlete dotado de cámara de aire, para asegurar la estanqueidad. Fácilmente sustituible. **2**
- Grupo frigorífico sobredimensionado, con desescarche automático.
- Frío ventilado, para conseguir la temperatura homogénea en el interior. **3**
- Gas refrigerante hidrocarburo, R290, ó R404a, de máximo rendimiento para obtener la calificación energética mas ecológica, y para reducir las emisiones de CO2.
- Puede conseguir las temperaturas de régimen deseadas y los ciclos indicados, a una temperatura ambiente de + 42°C.

## CONTROL ELECTRÓNICO

- Incorpora un panel de mandos táctil (TOUCH SCREEN), de muy fácil manejo, e intuitivo, desde el cual podrá elegir, si desea conservar o congelar. **4**
- También le permite almacenar hasta 99 programas.
- Dotados de sonda al corazón de serie **5**, que en el caso de trabajar con ella, no necesita preocuparse de elegir el ciclo (tiempo necesario) para conseguir la temperatura de conservación o de congelación deseada, ya que cuando se alcanzará, pasará automáticamente, al mantenimiento del producto como un simple refrigerador o mantenedor de congelados.
- Dicha sonda, cuando está en proceso de congelación, dispone de calefacción, para que sea fácilmente extraíble, una vez ha completado el ciclo.

## MODELOS PARA CARROS

- Con el grupo frigorífico en dotación de serie, para su montaje a distancia. La instalación no esta incluida, debiendo realizarla un servicio técnico frigorista.
- A petición del cliente, se puede suministrar sin el grupo remoto.
- Se pueden introducir carros, GN, directamente del horno de convección **6**, o estructuras normales de 20 niveles **7**, que opcionalmente se pueden suministrar. Así mismo disponemos de rampas para facilitar la introducción **8**. [Ver ACCESORIOS].

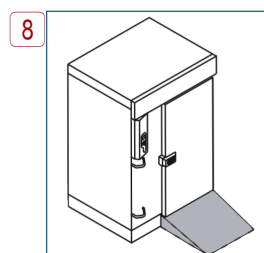
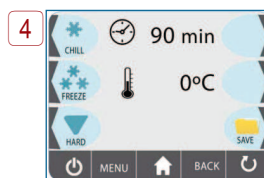
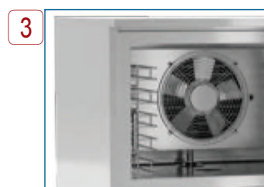
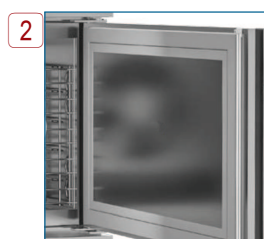



E

**WHAT IS A BLAST CHILLER?**

- It is a "Refrigerating cabinet for conservation (+) or freezing (-), with a very powerful group"
- Blast chillers prevent the reproduction of microorganisms in freshly prepared foods. The traditional way to preserve cooked food was to allow the product to cool, at room temperature, until it reached a suitable temperature, to place it in a refrigerator. Under these conditions, a remarkable bacterial proliferation is triggered in the food.
- With a blast chiller, time is saved, since the advanced preparation of food and blast chilling allow the cook to offer a more varied menu when required. With the simple operation of food regeneration, it is possible to serve many more dishes in a very short time.
- A freshly cooked and beaten product, can be introduced at + 90° C, can be consumed between 5 and 7 days. And if it freezes, the duration of the product can reach several months.
- Depending on the size of the blast chiller, the kilos of product that can be chilled vary, in storage or freezing temperatures.
- Likewise, the duration of the cycle is 90 minutes from + 90° to + 3° C, and 240 minutes from + 90° to -18° C.

**MAKING**

- Exterior and interior in 18/10 AISI-304 stainless steel.
- Internal tank with rounded edges, to facilitate cleaning, and drain at the base.
- Side guides for removable grids, by hand. Suitable for GN or EN. 65 mm separation between them. **1**
- Ecological injected polyurethane insulation (CFC-free), with a density of 42 Kgs./ m3 and 60/80 mm thick, depending on the model.
- With stainless steel legs.
- Torsion hinges, which allow opening up to 180°, with automatic return system.
- Door with built-in handle, with magnetic closure, by means of a weatherstrip with an air chamber, to ensure sealing. Easily replaceable. **2**
- Oversized refrigerator group, with automatic defrost.
- Cool ventilated, to achieve a homogeneous temperature inside. **3**
- Hydrocarbon refrigerant gas, R290, or R404a, of maximum performance to obtain the most ecological energy rating, and to reduce CO2 emissions.
- It can achieve the desired operating temperatures and indicated cycles, at an ambient temperature of + 42°C.

**ELECTRONIC CONTROL**

- It incorporates a touch control panel (TOUCH SCREEN), very easy to use, and intuitive, from which you can choose whether you want to keep or freeze. **4**
- It also allows you to store up to 99 programs.
- Equipped with a standard heart probe **5**, which in the case of working with it, you do not need to worry about choosing the cycle (necessary time) to achieve the desired storage or freezing temperature, since when it will be reached, it will automatically pass, to the maintenance of the product as a simple refrigerator or freezer.
- This probe, when it is in the freezing process, has heating, so that it is easily removable, once the cycle has been completed.

**TROLLEY MODELS**

- With the refrigeration unit supplied as standard, for remote mounting. The installation is not included, and must be carried out by a technical refrigeration service.
- Upon customer request, it can be supplied without the remote group.
- GN carts can be introduced directly from the convection oven **6**, or normal 20-level structures **7**, which can optionally be supplied. We also have ramps to facilitate the introduction **8**. (See ACCESSORIES).

F

**QU'EST-CE QU'UNE CELLULE DE REFROIDISSEMENT RAPIDE?**

- C'est une "Armoire frigorifique de conservation (+) ou de congélation (-), avec un groupe très puissant"
- Les cellules de refroidissement rapide empêchent la reproduction des micro-organismes dans les aliments fraîchement préparés. La façon traditionnelle de conserver les aliments cuits consistait à laisser le produit refroidir, à température ambiante, jusqu'à ce qu'il atteigne une température appropriée, pour le placer au réfrigérateur. Dans ces conditions, une remarquable prolifération bactérienne se déclenche dans les aliments.
- Avec une cellule de refroidissement rapide, le temps est gagné, car la préparation avancée des aliments et la réfrigération rapide permettent au cuisinier d'offrir un menu plus varié en cas de besoin. Avec la simple opération de régénération des aliments, il est possible de servir beaucoup plus de plats en très peu de temps.
- Un produit fraîchement cuit et battu, peut être introduit à + 90 ° C, peut être consommé entre 5 et 7 jours. Et s'il gèle, la durée du produit peut atteindre plusieurs mois.
- En fonction de la taille de la cellule de refroidissement rapide, les kilos de produits pouvant être réfrigérés varient en termes de températures de stockage ou de congélation.
- De même, la durée du cycle est de 90 minutes de + 90° à + 3° C, et de 240 minutes de + 90° à -18° C.

**CONSTRUCTION**

- Extérieur et intérieur en acier inoxydable 18/10 AISI-304.
- Réservoir interne aux bords arrondis, pour faciliter le nettoyage et vidanger à la base.
- Guides latéraux pour grilles amovibles, à la main. Convient pour GN ou EN. Séparation de 65 mm entre eux. **1**
- Isolation écologique en polyuréthane injecté (sans CFC), avec une densité de 42 Kgs./ m3 et 60/80 mm d'épaisseur, selon le modèle.
- Avec pieds en acier inoxydable.
- Charnières de torsion, qui permettent une ouverture jusqu'à 180°, avec système de retour automatique.
- Porte avec poignée intégrée, à fermeture magnétique, au moyen d'un coupe-froid avec chambre à air, pour assurer l'étanchéité. Facilement remplaçable. **2**
- Groupe réfrigérateur surdimensionné, à dégivrage automatique.
- Froid ventilé, pour atteindre une température homogène à l'intérieur. **3**
- Gaz réfrigérant hydrocarboné, R290 ou R404a, aux performances maximales pour obtenir la cote énergétique la plus écologique et réduire les émissions de CO2.
- Il peut atteindre les températures de fonctionnement souhaitées et les cycles indiqués, à une température ambiante de + 42°C.

**COMMANDE ÉLECTRONIQUE**

- Il intègre un panneau de commande tactile (ÉCRAN TACTILE), très facile à utiliser et intuitif, à partir duquel vous pouvez choisir si vous souhaitez conserver ou figer. **4**
- Il vous permet également de stocker jusqu'à 99 programmes.
- Équipé d'une sonde au coeur standard **5**, qui dans le cas de travailler avec lui, vous n'avez pas à vous soucier de choisir le cycle (temps nécessaire) pour atteindre la température de congélation ou de conservation souhaitée, car lorsqu'il est atteint, il passera automatiquement, à l'entretien du produit comme un simple réfrigérateur ou congélateur.
- Cette sonde, lorsqu'elle est en cours de congélation, est chauffée, de sorte qu'elle est facilement amovible, une fois le cycle terminé.

**MODÈLES POUR CHARIOT**

- Avec l'unité de réfrigération fournie en standard, pour un montage à distance. L'installation n'est pas incluse et doit être effectuée par un service technique de réfrigération.
- Sur demande du client, il peut être fourni sans le groupe distant.
- Les chariots GN peuvent être introduits directement depuis le four à convection **6** ou des structures normales à 20 niveaux **7**, qui peuvent être fournies en option. Nous avons également des rampes pour faciliter l'introduction **8**. (Voir ACCESSOIRES)



# ABATIDORES DE TEMPERATURA



E BLAST CHILLERS F CELLULES DE REFROIDISSEMENT RAPIDE

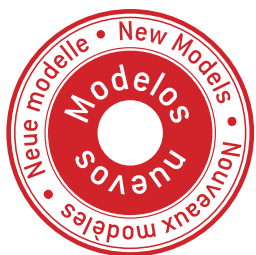

▲ 54498850 **GAS R290**

▲ 54598850 **GAS R404a**

## PANEL TÁCTIL

## TOUCH SCREEN



1. Refrigeración a +3 °C
2. Congelación a -18 °C
3. Ciclo rápido
4. Marcha / paro
5. Menú
6. Pantalla inicial
7. Retroceder
8. Actualizar
9. Memoria programas
10. Esterilización preenfriamiento
11. Sonda al corazón

1. Cooling at +3 °C
2. Freezing at -18 °C
3. Fast cycle
4. Start / Stop
5. Menu
6. Home screen
7. Back
8. Update
9. Program memory
10. Precooling sterilization
11. Heart probe

1. Refroidissement à +3 °C
2. Congélation à -18 °C
3. Cycle rapide
4. Démarrer / Arrêter
5. Menu
6. Écran d'accueil
7. Retour
8. Mise à jour
9. Mémoire programme
10. Stérilisation pré-refroidissement
11. Sonder au cœur

**SONDA**  
E PROBE  
F SONDE

SERIAL



MOD. / COD.	Icon	Dimensions	GN	Kgs.		Power	Price
				+90° +3°C	+90° -18°C		
54498850	50	600x700x520	3 GN 1/1	15	6	410 W - 230/1V	3.380
54598850	105	800x700x850	5 GN 1/1 5 EN 400x600	23	13	1200 W - 230/1V	4.650





▲ 54698850



▲ 54798850

<p><b>SONDA</b></p> <p>E PROBE F SONDE</p> <p>SERIAL</p>	<p><b>PANEL TÁCTIL</b></p> <p>E TOUCH SCREEN F ÉCRAN TACTILE</p> <p>PAG. 60</p>
--	---

**GAS**  
R404a



MOD. / COD.	Icon: Person	Icon: Dimensions	GN EN	Kgs.		Icon: Power	€
				+90° +3°C	+90° -18°C		
54698850	145	800x800x1300	8 GN 1/1 8 EN 400x600	40	24	2000 W - 230/1V	4.885
54798850	155	800x800x1450	10 GN 1/1 10 EN 400x600	50	30	2000 W - 230/1V	6.495



# ABATIDORES DE TEMPERATURA



[E] BLAST CHILLERS [F] CELLULES DE REFROIDISSEMENT RAPIDE

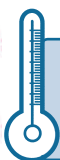
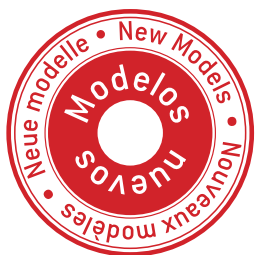

+90	+3 °C	90'
+90	-18 °C	240'
TEMP. +42°C		



54998850



54009850

**SONDA**  
[E] PROBE  
[F] SONDÉ



SERIAL

**PANEL TÁCTIL**  
[E] TOUCH SCREEN  
[F] ÉCRAN TACTILE

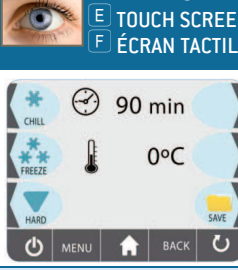

PAG. 60

**GAS**  
R404a



MOD. / COD.					Kgs.			€
					+90° +3°C	+90° -18°C		
54998850	200	800x800x1950	16 GN 1/1	16 EN 400x600	80	50	3500 W - 400/3V	8.565
54009850	265	1200x1050x1800	10 GN 2/1	10 EN 400x600	100	65	3500 W - 400/3V	10.725



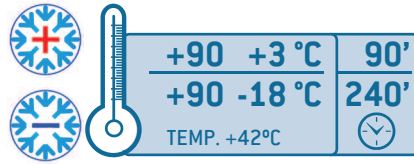

▲ 54395710



▲ 54495710



**SONDA**  
E PROBE  
F SONDE

SERIAL

**GRUPO REMOTO**  
E REMOTE GROUP  
F GROUPE À DISTANCE

SERIAL

**PANEL TÁCTIL**  
E TOUCH SCREEN  
F ÉCRAN TACTILE

PAG. 60

**ACCESORIOS**  
E ACCESSORIES  
F ACCESSOIRES

NO / NOT / NON INCLU.

MOD. / COD.	Icon: Person	Icon: Dimensions	Icon: GN	Kgs.		Icon: Power	€
				+90° +3°C	+90° -18°C		
54395710	380	1500x1250x2220	20 GN 1/1	70	48	4800 W - 400/3V	20.210
54495710	420	1700x1500x2220	20 GN 2/1	150	100	7350 W - 400/3V	24.200

# ACCESORIOS FRÍO INDUSTRIAL Y ABATIDORES DE TEMPERATURA

**E** INDUSTRIAL COLD ACCESSORIES AND BLAST CHILLERS

**F** ACCESSOIRES FROID INDUSTRIEL ET CELLULES DE REFRIGERATION RAPIDE

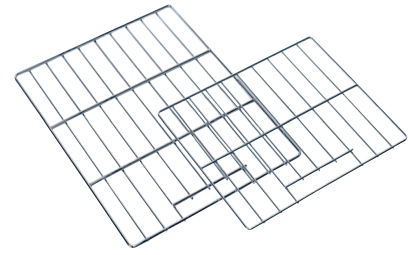
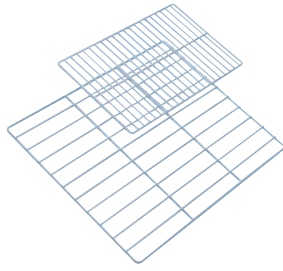

## REJILLAS PLASTIFICADAS **E** PLASTICIZED GRIDS **F** GRILLES PLASTIFIÉES

COD.	PARA <b>E</b> FOR <b>F</b> POUR	↔ ↗	€
46741091	MF 600	460x405	35
36741091	MF 600	525x405	35
63290000	MF-PP-PB-GC-AF GN 1/1	325x530	32
63304600	MF-AF EN	400x600	38
47741091	AF SERIE 5 - 720	560x542	42
63300000	AF GN 2/1 AF SERIE2 - 600	530x650	44
64931091	AF SERIE2 - 200/400	507x415	38
74931091	AF SERIE2 - 400/INFERIOR	507x225	36
94931091	AF SERIE2 - 600/INFERIOR	650x330	38

## REJILLAS ACERO INOX. GN - EN

**E** GN - EN STAINLESS STEEL GRIDS **F** GRILLES EN ACIER INOX. GN - EN

COD.	GN / EN	↔ ↗	€
31940000	1/1	325x530	36
31960000	2/1	530x650	64
37710000	EN	400x600	50

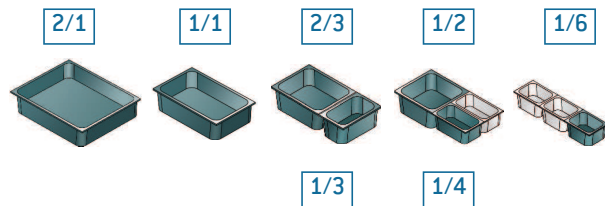

## SOPORTE REJILLA ( 4 UNID. )

**E** GRID SUPPORT (4 UNITS) **F** SUPPORT DE GRILLE (4 UNITÉS)

COD.	PARA <b>E</b> FOR <b>F</b> POUR	€
56741091	MF - 600	6

## RECIPIENTES GN **E** GN BACS **F** CONTENEURS GN

COD.	PARA <b>E</b> FOR <b>F</b> POUR	↔ ↗	GN	€
CP210651	AF	2/1	530x650x65	55
CP211001	AF	2/1	530x650x100	68
CP1106X1	MF	1/1	325x530x65	25
CP1110X1	MF	1/1	325x530x100	32
CP111501	GC	1/1	325x530x150	46
CP231501	GC / RI	2/3	352x325x150	45
CP131501	GC / RI	1/3	176x325x150	30
CP121501	GC / RI	1/2	325x265x150	29
CP141501	GC / RI	1/4	162x265x150	24
CP161501	GC / PP / PB	1/6	162x176x150	23

## PAR DE GUÍAS **E** GUIDES PAIR **F** PAREIL DE GUIDES

COD.	GN / EN	€
27501091	1/1 " U "	25
046CR000	2/1 " U "	36
047NR000	EN " L "	36

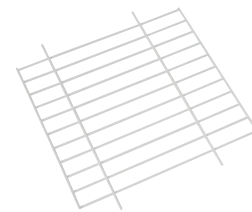

## SEPARADORES RECIPIENTES GN

**E** GN CONTAINER SEPARATORS **F** SEPARATEURS DE RECIPIENTS GN

COD.	PARA <b>E</b> FOR <b>F</b> POUR	GN	€
SEPAGN11	GC	1/1	14
SEPAGN13	RI	1/3	11
SEPAGN14	RI	1/4	10
SEPAGN16	PP / PB	1/6	9

## SEPARADOR VERTICAL BOTELLEROS

**E** BOTTLER VERTICAL SEPARATOR **F** SEPARATEUR VERTICAL DE BOUTEILLE

COD.	PARA <b>E</b> FOR <b>F</b> POUR	↗ ↕	€
66741091	BT	400x500	35
80340091	BT SERIE2	445x280	33

# ACCESORIOS FRÍO INDUSTRIAL Y ABATIDORES DE TEMPERATURA

**E** INDUSTRIAL COLD ACCESSORIES AND BLAST CHILLERS

**F** ACCESSOIRES FROID INDUSTRIEL ET CELLULES DE REFROIDISSEMENT RAPIDE



## KIT CAJÓN PICAMARROS

**E** SHIM FOR DRAWER **F** KIT TIROIR À MARCS

COD.	PARA <b>E</b> FOR <b>F</b> POUR	€
71400M70	CM	100

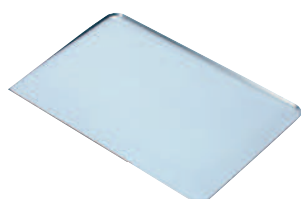

## LATAS EN

**E** PANS EURONORM **F** BOITES EURONORM

COD.	MATERIAL	↔ ↗ ↕	€
PI230600	AL.	400x600x10	42
PI231600	AL. PERFORADO	400x600x10	47
3770INOX	INOX	400x600x10	55



## CAJÓN PESCADO Y DOBLE FONDO INOX

**E** FISH DRAWER AND DOUBLE DEPTH INOX **F** TIROIR POISSON ET DOUBLE FOND INOX

COD.	PARA <b>E</b> FOR <b>F</b> POUR	↔ ↗ ↕	€
60874109	SERIE 8	400x600x120	86
60766077	AF SERIE2	400x600x180	88



## CESTA SERIE2

**E** BASKET SERIES 2 **F** PANIER SÉRIE 2

COD.	AF SERIE2	↔ ↗ ↕	€
03633091	150 200	450x427x190	30
13633091	400	450x190x190	28
55931091	600	310x515x180	30
65931091	600	600x300x180	28

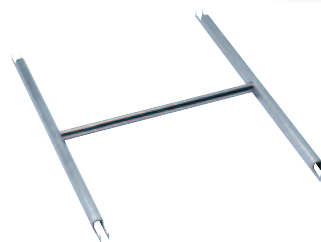

## KIT BARRA CARNICERA

**E** MEAT BAR **F** KIT BARRE DE BOUCHERIE

COD.	AF	€
28741091	SERIE 5	80
18741091	1/1 - 2/1	85



## INSTALACIÓN CERRADURA

**E** SAFETY INSTALLATION **F** INSTALLATION CLÉ

COD.	PARA <b>E</b> FOR <b>F</b> POUR	€
63340000	MF-AF	76



## JUEGO 4 RUEDAS - 2 CON FRENO

**E** SET OF 4 WHEELS - 2 WITH BRAKE **F** ENSEMBLE 4 ROULETTES - 2 AVEC FREIN

COD.	PARA <b>E</b> FOR <b>F</b> POUR	€
17900000	MF-AF	260

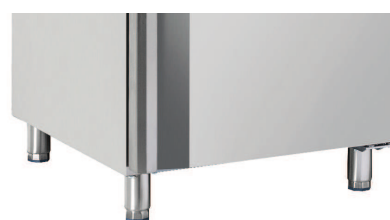

## KIT PATAS - 4 UNIDADES

**E** FOOT KIT - 4 UNITS **F** KIT DE PIEDS - 4 UNITÉS

COD.	PARA <b>E</b> FOR <b>F</b> POUR	€
PN671000	MF-AF	100

MF: Mesas Frías **E** Cold tables **F** Tour réfrigérées  
 AF: Armarios Fríos **E** Refrigerated cabinets **F** Armoires frigorifiques  
 RI: Refrigerador Ingredientes **E** Ingredient refrigerators **F** Ingrédients pour réfrigérateur  
 PP: Preparación Pizzas **E** Preparing pizzas **F** Préparation pizzas  
 PB: Preparación Bocadillos **E** Preparing snacks **F** Préparation du snack  
 GC: Gastro Cheff **E** Gastro Cheff **F** Gastro Cheff  
 BT: Botellero **E** Bottle collars **F** Rafraichisseur de boissons  
 CM: Contra mostrador **E** Refrigerated counters **F** Tours réfrigérées hautes

# ACCESORIOS FRÍO INDUSTRIAL Y ABATIDORES DE TEMPERATURA

E INDUSTRIAL COLD ACCESSORIES AND BLAST CHILLERS

F ACCESSOIRES FROID INDUSTRIEL ET CELLULES DE REFRROIDISSEMENT RAPIDE

STANDARD



## COLOCACIÓN MOTOR LADO IZQUIERDO

E LEFT SIDE MOTOR PLACEMENT F PLACEMENT DU MOTEUR CÔTÉ GAUCHE

COD.	PARA E FOR F POUR	€
CMIMFRIA	MF - MF GN	100

## TRASERO ACERO INOX.

E REAR STAINLESS STEEL F ARRIÈRE EN ACIER INOXYDABLE

COD.	↔	☐	€
TRIN1500	1500	2	200
TRIN1345	1345	2	180
TRIN2020	2020	3	270
TRIN1800	1800	3	240
TRIN2545	2545	4	340
TRIN2245	2245	4	300



## KIT LAVAMANOS MESAS FRÍAS

E COLD TABLES SINK KIT F KIT D'ÉVIER POUR TABLES FROIDES

COD.	€
63390000	470

## KIT GRIFO A PEDAL

E GRIFFIN PEDAL KIT F KIT PÉDALE GRIFFON

COD.	€
2222299	260

## GRIFO MONOMANDO

E SINGLE-LEVER TAP F ROBINET À LEVIER UNIQUE

COD.	€
2222236	105



## CARROS GN (75 MM)

E GN TROLLEYS (75 MM) F CHARIOTS GN (75 MM)

COD.	↔ ↗ ↕	☐ GN	€
91694009	460x630x1720	17 GN 1/1	675
98505009	665x750x1720	17 GN 2/1	725

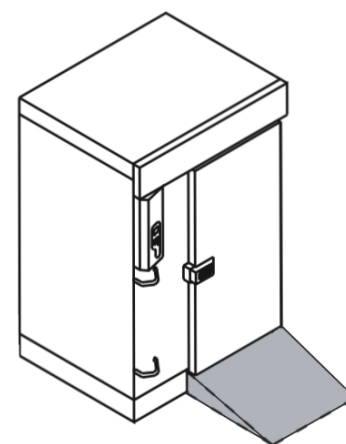

## CARROS HORNOS (65 MM)

E OVEN TROLLEYS (65 MM) F CHARIOTS DE FOUR (65 MM)

COD.	↔ ↗ ↕	☐ GN	€
41601520	463x751x1746	20 - 1/1	2.230
41701520	600x851x1746	20 - 2/1	2.320

## RAMPA ABATIDOR

E CHILLER RAMP F RAMPE DE REFRROIDISSEMENT

COD.	PARA E FOR F POUR	€
RA11ABAT	1/1	350
RA21ABAT	2/1	425



# SIMBOLOGÍA

E SYMBOLOGY  
F SYMBOLOGIE



## Largo

- E Length
- F Large

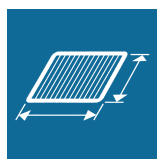

## Rejilla

- E Tray
- F Grille



## Dotación de serie

- E Standard equipment
- F Equipement standard



## Fondo

- E Width
- F Profond

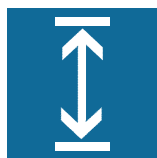

## Separación entre guías

- E Guide separation
- F Séparation des guides



## Gastronorm

- E Gastronorm
- F Gastronorm

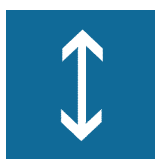

## Alto

- E Height
- F Haut



## Capacidad litros

- E Litres capacity
- F Capacité en litres



## Latas Euronorm

- E Euronorm tinplate
- F Fer-blanc Euronorm



## Peso

- E Weight
- F Poids



## Frío positivo

- E Positive cold
- F Froid positif



## Cajones pescado

- E Drawers fish
- F Tiroirs poissons



## Puertas

- E Doors
- F Portes



## Frío negativo

- E Negative cold
- F Froid négatif



## Producción horaria

- E Hourly production
- F Production horaire



## Puertas reversibles

- E Reversible doors
- F Portes réversibles



## Frío ventilado

- E Cold ventilated
- F Froid ventilé



## Producción / Capacidad

- E Production / Capacity
- F Production / Capacité



## Cajones

- E Drawers
- F Tiroirs



## Frío estático

- E Static cold
- F Froid statique



## Eléctrico

- E Electric
- F Électrique



## Cerradura

- E Lock
- F Verrouiller



## Desescarche automático

- E Automatic defrost
- F Dégivrage automatique



## Precio en EUROS

- E Price in EUROS
- F Prix en EUROS



## Luz

- E Light
- F Lumière



## Regimen de trabajo / Temperatura ambiente

- E Working regime / ambient temperature
- F Régime de travail / température ambiante



## PRECIOS

Los precios de la presente tarifa son P.V.P. (Impuestos no incluidos - IVA)



## FORMAS DE PAGO

En construcciones especiales 30% al pasar el pedido

### CONTADO

Descuento Por pago anticipado 2%  
1a operacion: contado al pasar el pedido.  
Una vez concedido el crédito, la forma de pago será 30, 60 días fecha factura.

### CREDITO

En facturas de hasta 300€, el pago será a 30 días fecha factura



## PORTES EN ESPAÑA

Pagados en península y Baleares, a partir de 300,- €. En caso de importe inferior (base imponible), se cargarán en factura.



## CARACTERÍSTICAS TÉCNICAS

Como fabricantes, nos reservamos el derecho de modificar sin previo aviso las características que constan en este catálogo, en beneficio de mejorar nuestros productos.



## GARANTIA

La garantía se concede solamente en los defectos de fabricación quedando excluidos de ella la utilización indebida.

### PIEZAS

Dicha garantía es de 12 meses en piezas defectuosas, siendo por cuenta del cliente los portes de ida y vuelta de dichas piezas. Todo material remitido en garantía se facturará y se procederá a su correspondiente abono, una vez remitidas las piezas defectuosas y comprobadas por parte del fabricante.

### MANO DE OBRA

El servicio de mano de obra y los desplazamiento son siempre por cuenta del cliente. El fabricante no se hará cargo en ningún caso de ningún tipo o clase de indemnización.



## JURISDICCIÓN

Serán únicamente competentes, en caso de litigio, los tribunales de Barcelona.

## E SALES CONDITIONS

## F CONDITIONS DE VENTE



### E PRICES

The prices in this list are retail prices (EX-WORKS).

### F PRIX

Les prix du présent tarif correspondent à des Prix de Vente au



### E PAYMENT CONDITIONS

Irrevocable letter of credit or Swift.

### F FORME DE PAIEMENT

Lettre de crédit bancaire irrévocable o virement bancaire



### E TECHNICAL CHARACTERISTICS

The manufacturer reserves the right to modify the characteristics mentioned in this catalogue to improve the quality of the products, without previous advice.

### F CARACTERISTIQUES TECHNIQUES

En tant que fabricants, nous nous réservons le droit de modifier sans préavis, les caractéristiques indiquées dans le pré-



### E GUARANTEE

The guarantee only covers manufacturing defects and excludes unauthorized use.

#### PARTS

The guarantee for defective parts are 12 months. All shipping costs are to be paid by the consumer.

The manufacturer does not accept any responsibility for any type of compensation.

### F GARANTIE

La garantie couvre uniquement les défauts de fabrication, une utilisation incorrecte en étant totalement exclue.

#### PIECES

Cette garantie est de 12 mois sur les pièces défectueuses, leurs transports d'aller et de retour étant à la charge du client.



### E JURISDICTION

In the event of legal action, the only Courts considered competent are those of Barcelona (Spain)

### F JURIDICTION

En cas de litige, seuls les Tribunaux de Barcelona (Espagne) seront compétents.